



HOT DEALS

2026-1

20

2006 - 2026
YEARS



EINFACH VIGOR.

Valid from March 01, 2026 until August 31, 2026 – errors excepted



Follow us!



HOT26-1/EN/XX/0

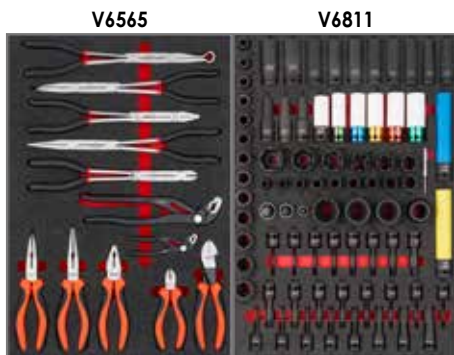
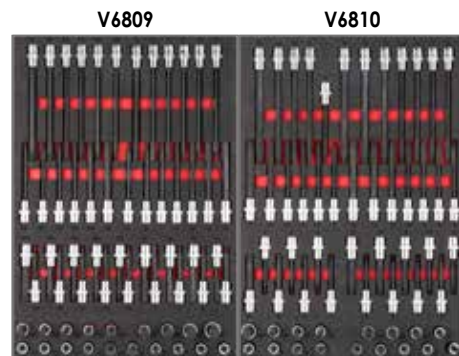
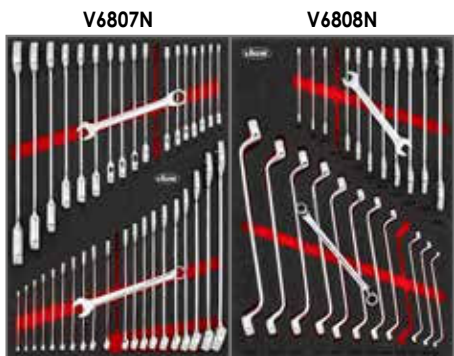

929

tools including tool trolley

+

Including can holder V2393-XD

You can find the list of items for the tool trolley here!



VIGOR No.		Designation	EAN
V4481-XXL/929	929	Tool trolley with stainless steel worktop and assortment 1	4047728+ 082303

ASSORTMENT 2 Including tool trolley with stainless steel worktop + all inserts from assortment 1!

New

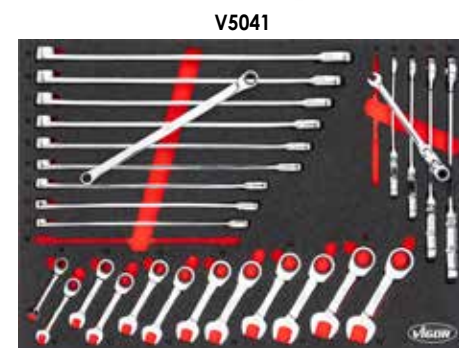

1299

tools including tool trolley



+



Including can holder V2393-XD and 5x soft foam insert V5008!

VIGOR No.		Designation	EAN
V4481-XXL/1299	1299	Tool trolley with stainless steel worktop and assortment 2	4047728+ 091138

The space saver!

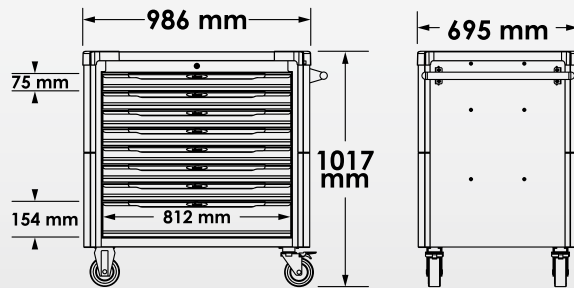

» With stainless steel worktop



V4481-XD
EAN 4047728066488



Tool trolley, empty

EXTRA DEEP!

ASSORTMENT 1

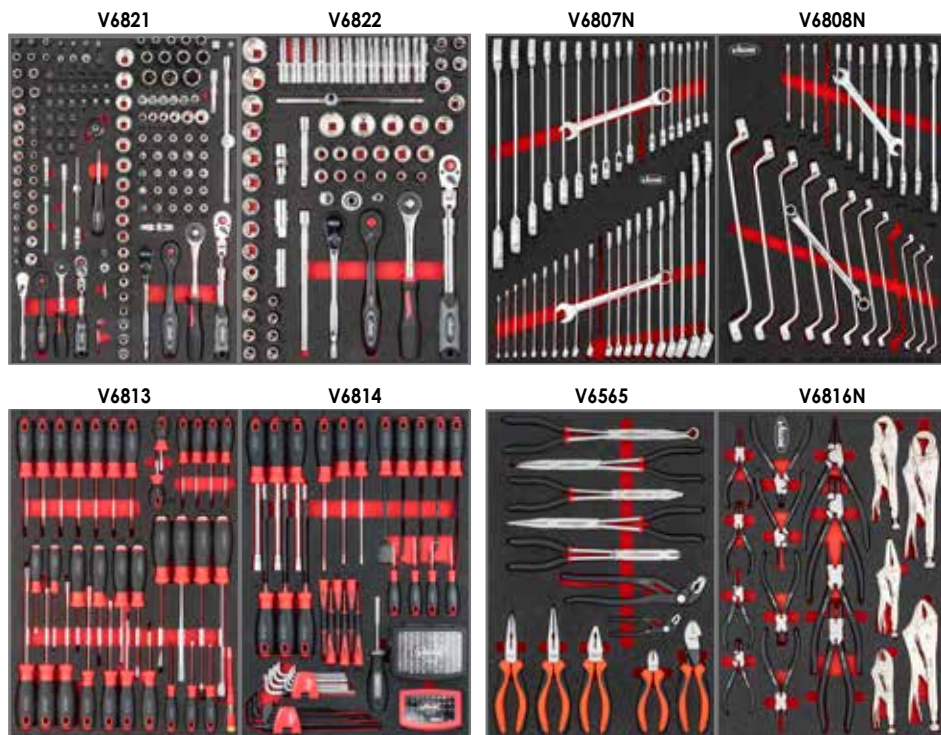

You can find the list of items for the tool trolley here!

469

tools including tool trolley

VIGOR No.		Designation	EAN 4047728+
V4481-XD/469	469	Tool trolley with stainless steel worktop and assortment 1	068512

ASSORTMENT 2

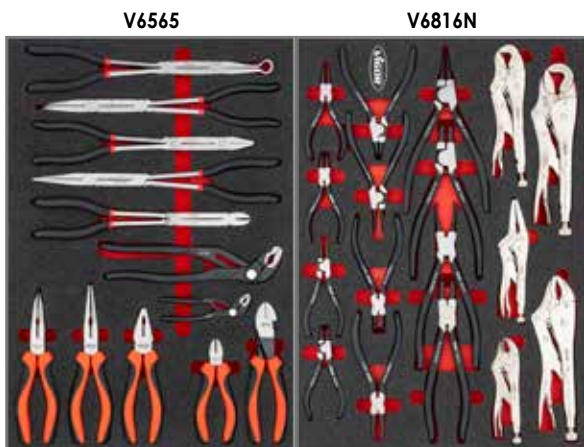
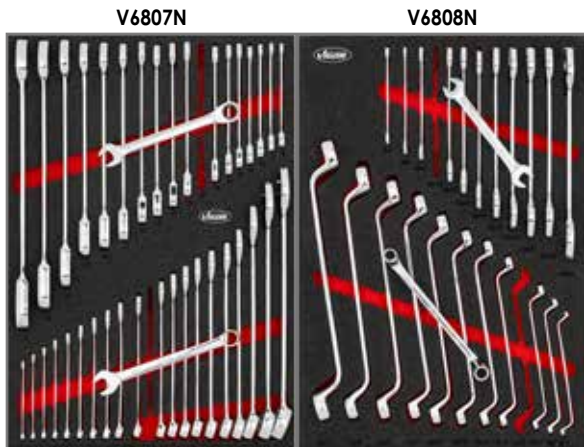
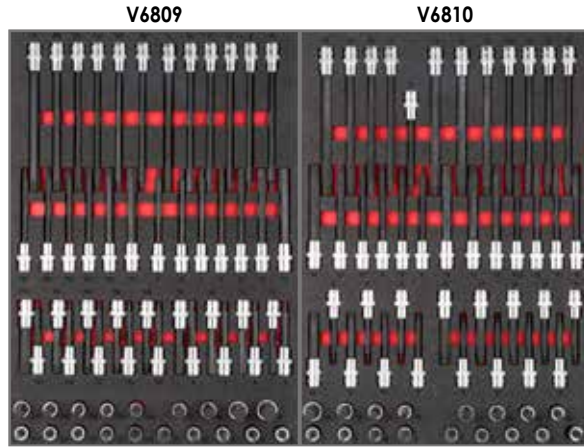
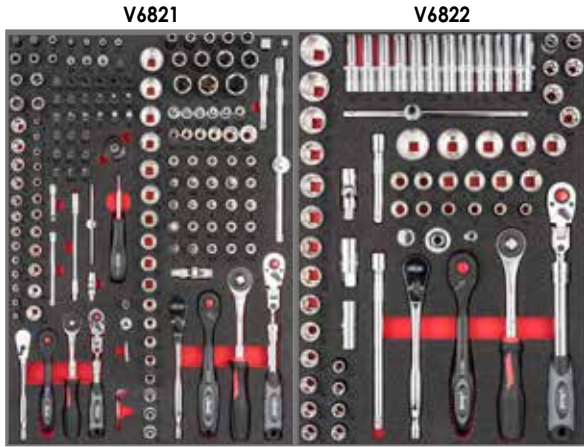

You can find the list of items for the tool trolley here!

775

tools including tool trolley

VIGOR No.		Designation	EAN 4047728+
V4481-XD/775	775	Tool trolley with stainless steel worktop and assortment 2	068529



VIGOR XL SERIES

XL

- 25 kg 8 x
- 753 x 398 x 75 mm 7 x
- 753 x 398 x 154 mm 1 x
- 500 kg
- Stainless Steel
- RAL 9005 7012

With stainless steel worktop



Tool trolley available with assortment 1, 2 or 3!



Drawers:
• 7x flat
• 1x high



V4481-X
EAN 4047728060721

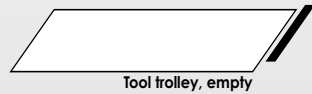

Tool trolley, empty

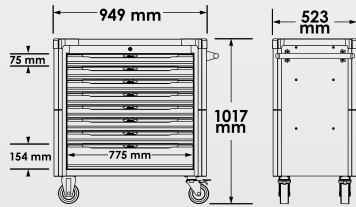

With plastic worktop

Tool trolley available with assortment 1, 2 or 3!



Drawers:
• 7x flat
• 1x high

V4481
EAN 4047728044813

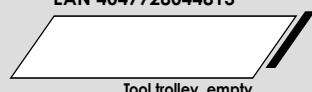

Tool trolley, empty

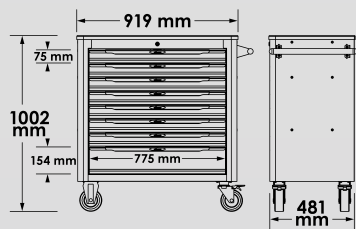

ASSORTMENT 1



499 tools including tool trolley

ASSORTMENT 2

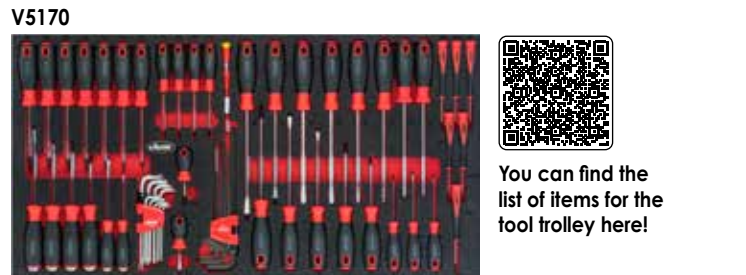
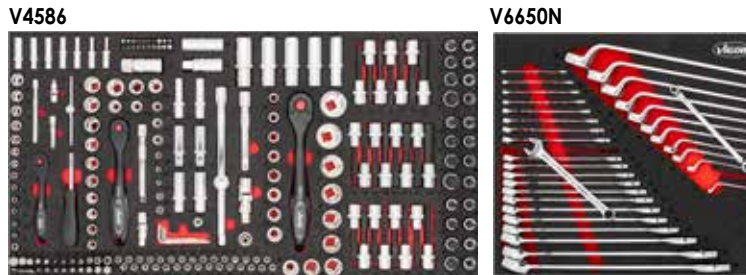

You can find the list of items for the tool trolley here!

ASSORTMENT 3

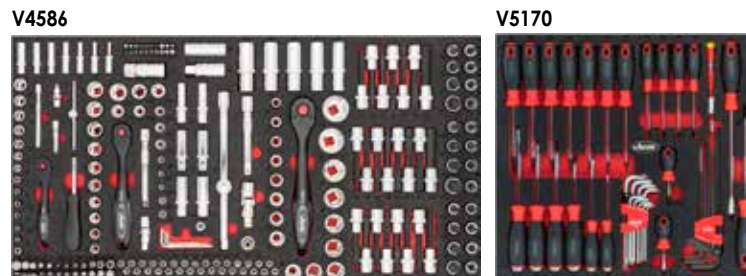

375 tools including tool trolley

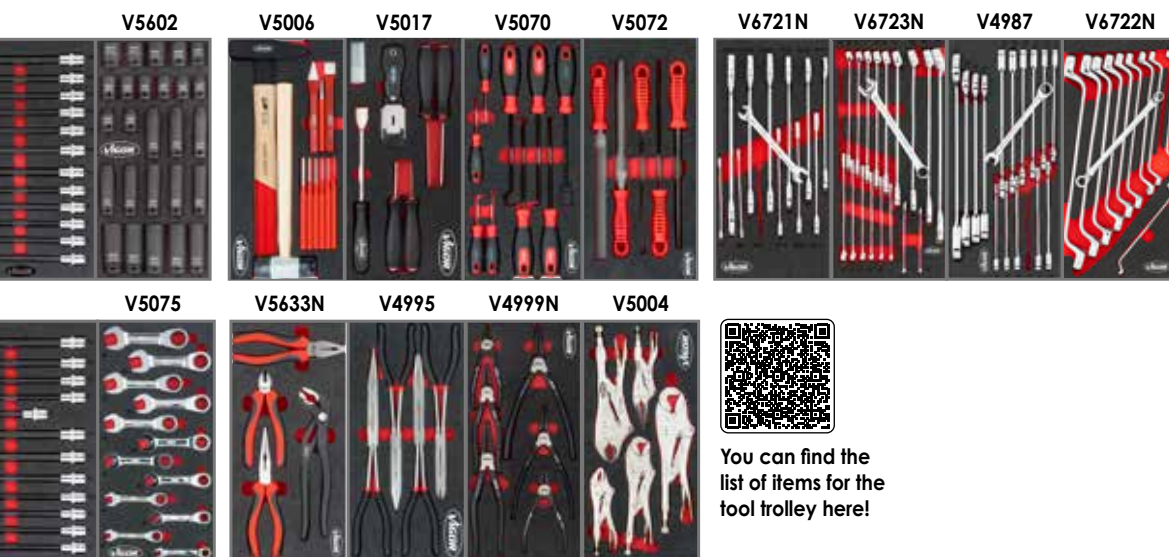

You can find the list of items for the tool trolley here!

VIGOR No.		Designation	EAN 4047728+
V4481-X/499	499	Tool trolley with stainless steel worktop and assortment 1	062367
V5434	499	Tool trolley with plastic worktop and assortment 1	054348



466 tools including tool trolley



VIGOR No.		Designation	EAN 4047728+
V4481-X/466	466	Tool trolley with stainless steel worktop and assortment 2	074674
V4481/466	466	Tool trolley with plastic worktop and assortment 2	088329



You can find the list of items for the tool trolley here!

VIGOR No.		Designation	EAN 4047728+
V4481-X/375	375	Tool trolley with stainless steel worktop and assortment 3	062350
V4542	375	Tool trolley with plastic worktop and assortment 3	045421



VIGOR L SERIES

L	25 kg 8 x	7 x 569 x 398 x 75 mm	1 x 569 x 398 x 154 mm	500 kg	3	RAL 9005 7012
---	--------------	--------------------------	---------------------------	--------	---	------------------

With stainless steel worktop



Tool trolley available with assortment 1, 2 or 3!



- Drawers:**
- 7x flat
 - 1x high

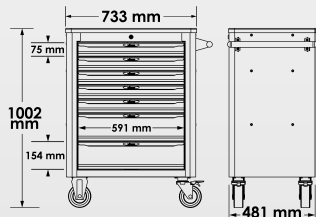

With plastic worktop

Tool trolley available with assortment 1, 2 or 3!



- Drawers:**
- 6x flat
 - 2x high

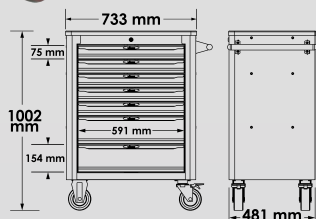
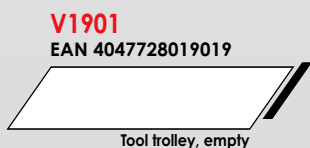

ASSORTMENT 1

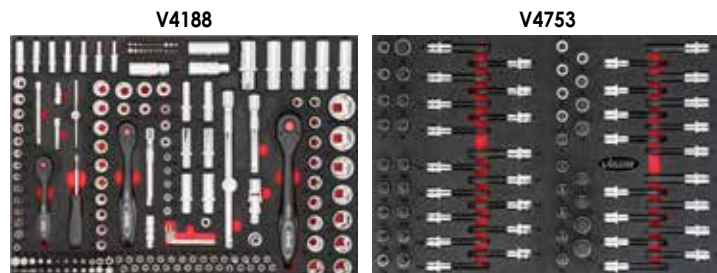

ASSORTMENT 2

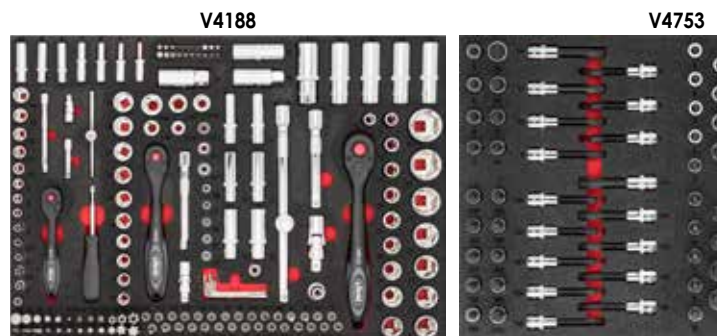

You can find the list of items for the tool trolley here!

376
tools including
tool trolley

ASSORTMENT 3



You can find the list of items for the tool trolley here!

248
tools including
tool trolley

V6724N

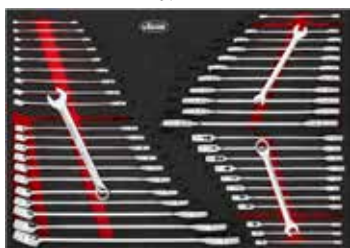

V5006



V5017



V4995



V5068

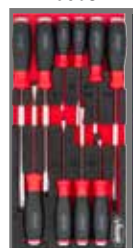

V4991



V5070



You can find the list of items for the tool trolley here!

442 tools including tool trolley

VIGOR No.		Designation	EAN 4047728+
V1901-X/442	442	Tool trolley with stainless steel worktop and assortment 1	084338
V1901/442	442	Tool trolley with plastic worktop and assortment 1	088336

V6724N

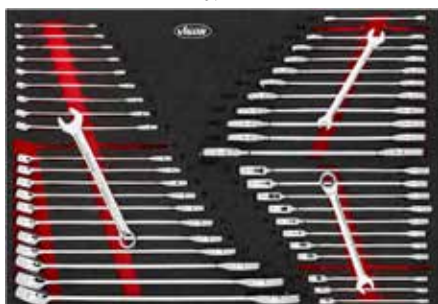

V5068



V5070



V5006



V5633N



V5603



V7324N



VIGOR No.		Designation	EAN 4047728+
V1901-X/376	376	Tool trolley with stainless steel worktop and assortment 2	084192
V1901/376	376	Tool trolley with plastic worktop and assortment 2	080293

V5637N



VIGOR No.		Designation	EAN 4047728+
V4219-X	248	Tool trolley with stainless steel worktop and assortment 3	084185
V4219	248	Tool trolley with plastic worktop and assortment 3	042192



With mat

Tool trolley available with assortment 1 or 2!

Drawers:
• 5x flat
• 2x high

L x W x H
681 x 460 x 1016 mm

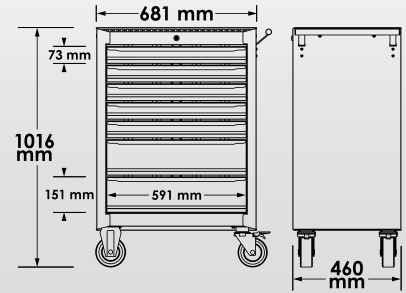

ASSORTMENT 1



V5116

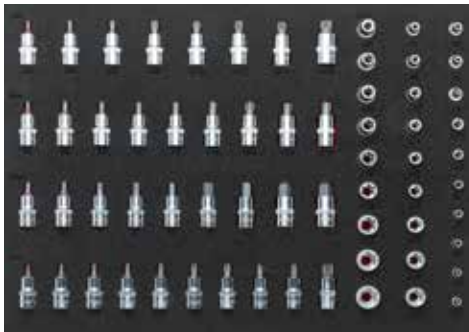

V2837

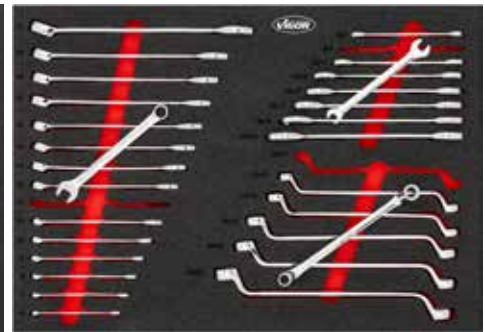

V6726N



V5111N

320

tools including tool trolley



You can find the list of items for the tool trolley here!

VIGOR No.	XX	Designation	kg	EAN 4047728+
V2712N	320	Tool trolley with mat and assortment 1	77	055451

ASSORTMENT 2



V5116



V5111N

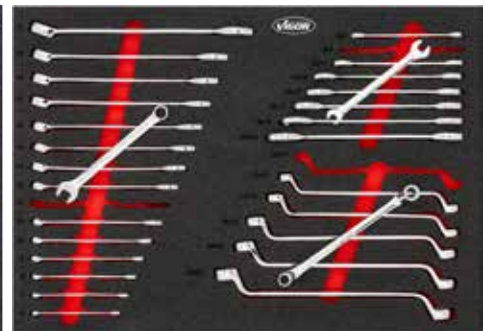

V6726N

238

tools including tool trolley



You can find the list of items for the tool trolley here!

VIGOR No.	XX	Designation	kg	EAN 4047728+
V2379N	238	Tool trolley with mat and assortment 2	72	055444

STARTER KIT · 700 mm DEPTH

Storage system

- 3-module combination in wide and deep design
- Available with wooden or stainless steel worktop
- Including side veneer
- Full extension: 700 mm

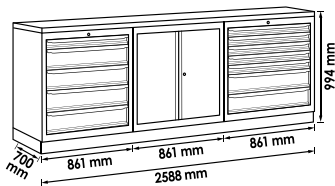
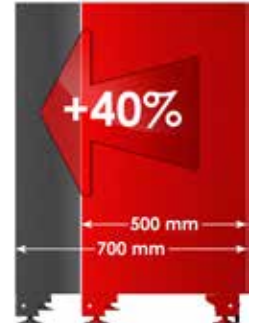
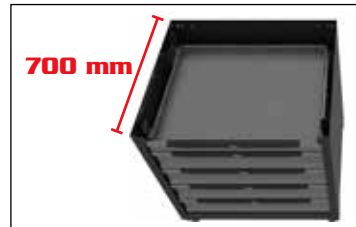
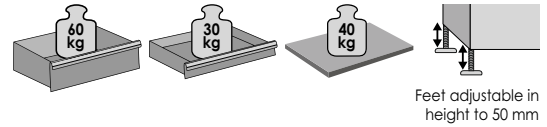

VIGOR No.	Designation	EAN 4047728+
V6000-3P1XLD	Storage system combination · starter kit · wooden	087001
V6000-3P1XLD-X	Storage system combination · starter kit · stainless steel	086998

COMPACT KIT · 700 mm DEPTH

Storage system

- 3-module combination in wide and deep design with perforated panel structure and wall cabinets
- Extra-deep high cabinet with double-hinged door
- Available with wooden or stainless steel worktop
- Including side veneer
- Full extension: 700 mm

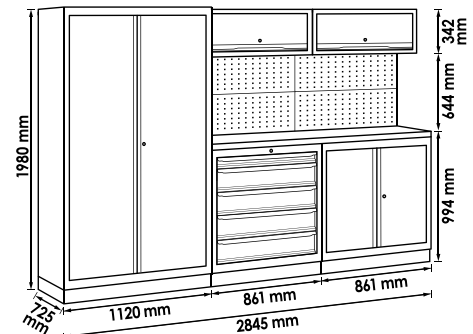
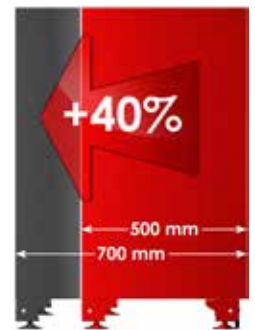
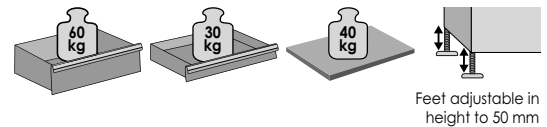

VIGOR No.	Designation	EAN 4047728+
V6000-3XD	Storage system combination · compact kit · wooden	087018
V6000-3XD-X	Storage system combination · compact kit · stainless steel	087025

Find your tool on our homepage!

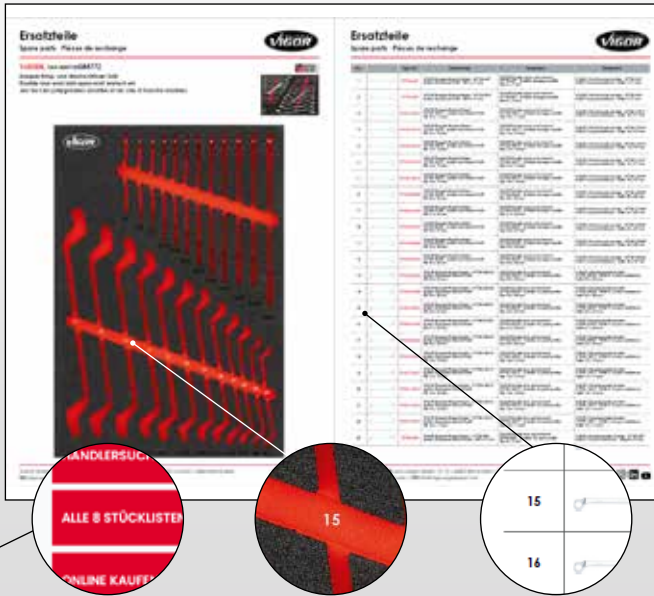

- Three clicks to find the missing part
- Easy search via your tool trolley or your insert



V6000-063XD

EAN 4047728086158

700 mm DEPTH

Pull-out cupboard

- Robust sheet-steel design, fully assembled
- 2 doors with internal hinges and hidden closing linkages
- Maximises the available storage room thanks to efficient vertical use, ideal for areas with limited space
- Pull-out shelves allow for quick access
- Four vertical slide-out perforated tool panels with a double-sided hole matrix
1590 x 490 mm (max. loading capacity 120 kg per panel)
- Punching 9 x 9 mm, hole matrix 38 x 38 mm, suitable for VIGOR accessories
- For storing tools, workwear, hoses, cables
- Wall installation required

»» Wall installation required!

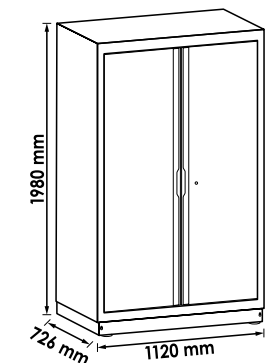
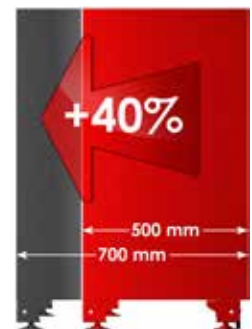

Everything within reach and perfectly organised – our pull-out cupboard is your new stylish workshop shelf!

V6000-037N

EAN 4047728090391

New

Bridge-type lower cabinet

- Hinged-door with magnetic lock
- Four feet adjustable in height
- Same as Series XD
- Storage shelf adjustable in height
- Depth: 700 mm
- Width: 341 mm

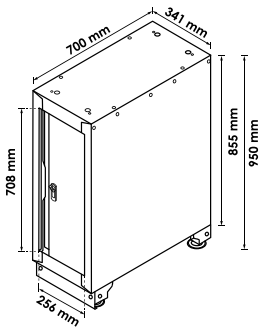

V6000-038

EAN 4047728090384

New

Hose/cable reel cabinet

- Can be combined: 2 x cable reel 9040D-2.5 or 1 x cable reel 9040D-2.5 and 9040N-10 or 9040N-13 or 2 x 9040N-10
- Depth: 700 mm
- Width: 341 mm

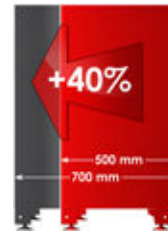
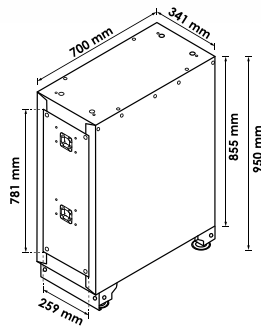

V6000-057XL

EAN 4047728083065

Washbasin lower cabinet

- Full-length sink made of 18/10 stainless steel
- Can be retrofitted into existing systems
- Ready for a tap to be installed
- Includes a continuous back panel and drain hose



Drain set included

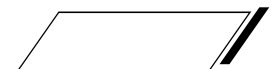
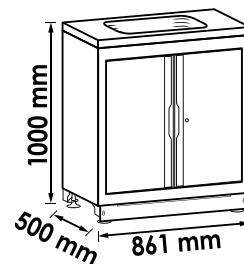

V1901-X-EV/66

EAN 4047728**089913**

Tool trolley including insulated tool assortment



EV = electric vehicle

New



①

V2024



Insulated nut-driver and pliers set

- Size: 6 – 22 mm
- Inside hexagon: 4, 5, 6, 8, 10

②

V2025

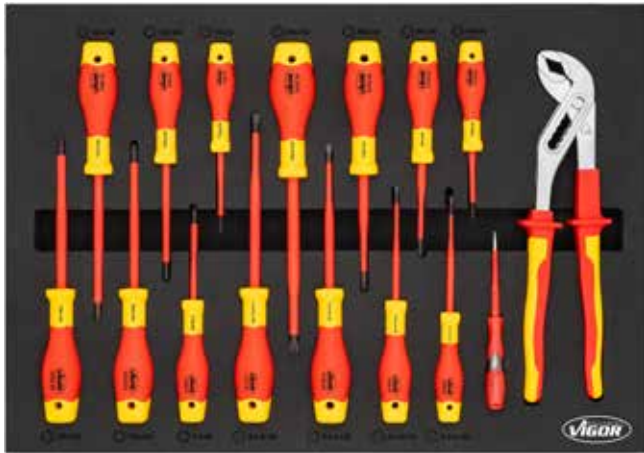

Insulated screwdriver set

- PH0 · PH1 · PH2 · PH3
- 0.5 x 3.0 · 0.8 x 4.0 · 1.0 x 5.5 · 1.2 x 6.5

③

V2026



Insulated wrenches

- Size: 6 – 19, 21, 22, 24, 27, 30, 32 mm

VIGOR No.		Designation	EAN 4047728+
V1901-X-EV/66	66	Tool trolley with insulated tool assortment	089913
V1901-X-EV	–	Tool trolley, empty	089081

VIGOR No.		Designation	EAN 4047728+
① V2024	30	Insulated nut-driver and pliers set	089111
② V2025	16	Insulated screwdriver set	089104
③ V2026	20	Insulated wrenches	089098

VIGOR No.	Designation	EAN 4047728+
V2024-L	Soft foam insert, empty	089142
V2025-L	Soft foam insert, empty	089470
V2026-L	Soft foam insert, empty	089593

V5632N

EAN 4047728089807

EV tool case · 27-piece

- Compact tool case with all the tools needed to safely de-energise a vehicle
- Certified according to DIN EN 60900 up to 1000 volts alternating voltage or 1500 volts direct voltage
- For manual operation



New



- 7 · 8 · 10 · 12 · 13 · 14 · 17 mm
- PH1 · PH2 · 0.8 x 4.0 · 1.0 x 5.5
- 3/8"
- 125 mm
- 7 · 8 · 10 · 12 – 15 · 17 · 19 · 22 mm
- 170 mm
- 190 mm

27

V2027N

EAN 4047728089814

EV screwdriver set · 7-piece

- 7-piece insulated screwdriver set
- Manufactured according to DIN/ISO
- PH0 · PH1 · PH2
- 0.5 x 3.0 · 0.8 x 4.0 · 1.0 x 5.5 · 1.2 x 6.5



New



7

V2542N

EAN 4047728088961

Universal case

- High-quality universal tool case for professional and workshop tools
- Robust, lockable hard-shell design for maximum durability



New



VIGOR No.	Designation	EAN 4047728+
V2400N	Universal case · empty	088978

144

V2470N

EAN 4047728087612

Inch tool case

- For manual operation
- Comprehensive tool set with dimensions in inches - ideal for vehicles from the American market
 - FORD Mustang
 - CHEVROLET Camaro
 - DODGE Charger
 - JEEP Wrangler
 - HARLEY DAVIDSON
 - and many more.
- Robust case for safe transport of tools
- Robust reversible ratchet with fine toothing for precise work



- 5/32 · 3/16 · 7/32 · 1/4 · 9/32 · 5/16 · 11/32 · 3/8 · 7/16 · 1/2"
- 1/4 · 5/16 · 3/8 · 7/16 · 1/2"
- 1/2 · 9/16 · 19/32 · 5/8 · 11/16 · 3/4 · 25/32 · 13/16 · 7/8 · 15/16 · 1"
- 9/16 · 5/8 · 11/16 · 3/4"
- 1/4 · 5/16 · 3/8 · 7/16 · 1/2 · 9/16 · 5/8 · 11/16 · 3/4"
- 1/16 · 5/64 · 3/32 · 1/8 · 5/32 · 3/16 · 1/4 · 5/16 · 3/8"
- 150 mm
- 198 mm
- 5/8 · 3/4 · 13/16"



92

V2414N

EAN 4047728056434

Socket set

• For manual operation



46

V2461N

EAN 4047728056472

Socket set

• For manual operation



172

V5461

EAN 4047728080323

Socket set

• For manual operation



12-point

133

V3277N

EAN 4047728056489

Socket set

• For manual operation



212

V2318N

EAN 4047728059299

3/4" Socket set

• For manual operation

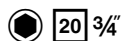

21

V7920N

EAN 4047728081702

T-plus socket set

• For manual operation



60

V4914

EAN 4047728087230

T-handle ratchet

- Ideal for precise screwdriving work in confined spaces
- Switching function for quick changeover between forward and reverse
- Can be converted to a T-handle – for maximum force transmission with tight screws
- Fine-toothed for controlled work with a low return angle
- Ergonomic design for comfortable handling even during long periods of use



6.3 1/4"

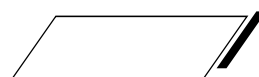

V7784

EAN 4047728077842

Ratcheting wrench screwdriver bit set

- Good accessibility for hard-to-reach places: Screwdriver bits are inserted in the ratchet → ratchet head height very low
- Bit assortment with 10 mm hexagon socket
- 2 sockets: Rigid side for loosening tight screw connections, Bit ratchet socket with fine toothing of 72 teeth
- Long ratchet wrench: 250 mm

10 3/8"



40

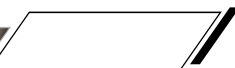

V4970

EAN 4047728086219

Telescopic ratchet set

- 180° swivel head with locking mechanism
- Quick-release press-button
- For manual operation
- Including extension 75 and 250 mm

6.3 1/4" 10 3/8" 12.5 1/2" 20 3/4"
6.3 1/4" 10 3/8" 12.5 1/2" 20 3/4"

S



17



VIGOR No.

Designation

EAN 4047728+

V4970-L

Telescopic ratchet insert S · empty

086110

V7016/6

EAN 4047728087285

Glow plug extractor set

- Hinge on the socket for optimum accessibility even in tight spaces
- Integrated magnet holds the glow plug securely – no falling out during removal
- Gentle and precise disassembly – reduces the risk of breakage of sensitive glow plugs
- Robust quality for professional workshop use
- Ideal for diesel vehicles in the passenger car and commercial vehicle sector
- Size: 8 – 10, 12, 14, 16 mm



10 3/8"



6

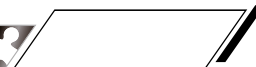

V7513

EAN 4047728087728

Flexible head wrench set*

- For manual operation
- Ideal for screwdriving work on engines, gearboxes, chassis and tight installation spaces
- No additional universal joint required – compact and efficient
- Size: 10 – 19 mm

10 3/8"

*Also available individually!



10

V6202

EAN 4047728062022

Socket set · super flat

- Flat insert profile – direct attachment to the nut/screw connection
- Robust solid steel reversible ratchet
- Right and left-hand operation
- Ergonomic handle
- Sockets without chamfered edge
- Super short sockets make it possible to work in very tight spaces
- Size: 8 – 17, 19, 21, 22 mm

10 3/8"



18

V4883

EAN 4047728087841

Flexible handle 990 mm 3/4"

- Extra long and robust design
- 180° swivelling head
- Ideal for loosening tight bolts and nuts on trucks, passenger cars and construction and agricultural machinery

20 3/4"

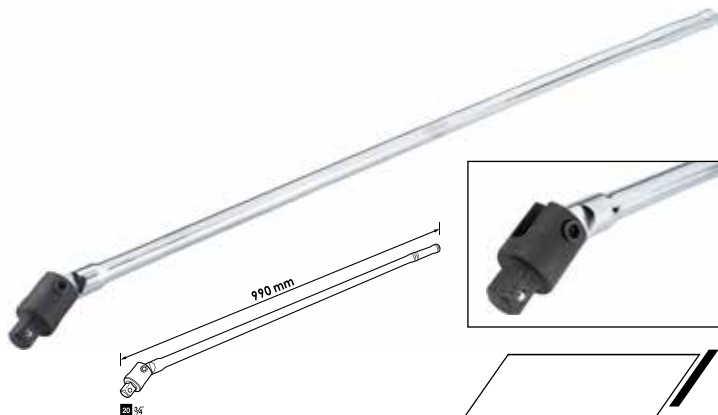

V7031

EAN 4047728082624

Ratcheting box-end wrench · extra long

- At least 60 % longer than standard ratchet wrenches – for greater power transmission
- Slim design
- Tool roll
- Surface: chrome-plated, polished
- 72 teeth
- Size: 10 – 19 mm



10

V5010/12

EAN 4047728086981

Screwdriver with impact cap · including square

- 2-component handle
- Screwdriver with impact cap
- Hexagon at the blade
- 1/4" square in the impact cap
- PH0 · PH1 · PH2 · PH3 · PH4
- 3.5 x 38 · 3.5 x 75 · 5 x 100 · 6 x 125 · 8 x 150 · 10 x 200

6.3 1/4"



12

V6850/6

EAN 4047728087629

Bolt cleaner

- For quick and effective cleaning of wheel bolts and stud bolts
- Removes rust, dirt and adhesions for optimum contact surfaces
- Ensures correct fit of the rim and prevents assembly problems
- Suitable for use with cordless screwdriver or drilling machine
- 1/2" socket



V6850-13



Ø 13 mm

V6850-14



Ø 14 mm

V6850-22



Ø 22 mm

V6850-12



Ø 12 mm

V6850-16



Ø 16 mm

V6850-18



Ø 18 mm

VIGOR No.	Ø mm	Designation	EAN 4047728+
V6850-12	12	Bolt cleaner	087636
V6850-13	13		087643
V6850-14	14		087650
V6850-16	16		087667
V6850-18	18		087674
V6850-22	22		087698

8

V6050

EAN 4047728086141

One-hand multifunctional wrench

- Chrome-vanadium
- Multifunctional wrench with ratchet function
- Automatic adjustment to the screw size
- Wrench sizes: 8 - 17 · 14 - 32
- Self-clamping
- Line wrench
- Ratchet function

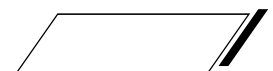

PIPE WRENCHES

- Robust cast iron pliers body enables high power transmission
- Quick canting and release on the workpiece due to internal spring
- Coarse jaw serration for optimum grip



Our 5 pipe wrenches –
Your problem-solving team



HEAVY DUTY
Continuously adjustable

New



	VIGOR No.	Jaw opening up to	Length mm	⚖️ kg	EAN 4047728+
①	V5639-6	33 mm	130	0.23	086134
②	V5639-8	46 mm	170	0.39	086127
③	V5639	60 mm	350	1.3	075589
④	V5639-24	88 mm	620	3.2	081719
⑤	V5639-36	150 mm	760	8.72	089135

V6200-XXL

EAN 4047728087940

Drift pin set · 3 pieces · 18, 22, 25 mm

- Drift pins made of hardened tool steel in XXL format with sturdy hand guard
- For driving through axles, shafts, bolts, splint pins and pins in the following sectors:
 - Commercial vehicles
 - Agricultural machinery
 - Motor vehicles
 - Motorcycles
 - Industry
 - Trade

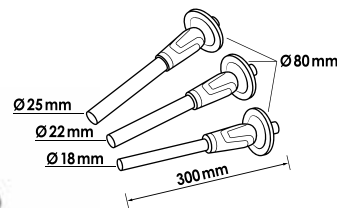

HEAVY DUTY

3

V1001/2

EAN 4047728**086752**

Impact rod set

- Diameter 25 mm and 16 mm
- Exchangeable nylon caps
- Impact rod 25 mm with steel ball filling (non-rebound)
- Extension for hammer
- Precise and secure impact possible



2

V1571N

EAN 4047728**088077**

Steering wheel level

- For alignment of the steering wheel during axle alignment and work around the steering column
- Universally suitable for steering wheels with an inner diameter of 170 mm to 250 mm and 280 mm to 350 mm
- Optimum centring and clamping due to spring force
- Easy to read
- Can be used for passenger cars, vans and trucks
- Using the steering wheel level prevents complaints due to a misaligned steering wheel after track adjustment



V1786/5

EAN 4047728**086448**

Workshop filing set

- Versatile set with 5 file shapes: flat, half-round, round, triangular, square
- Teeth (cut): 2 = medium
- Ergonomic handle shape for a secure grip and comfortable working
- Ideal for workshops, trade and industry



5

V1886/3

EAN 4047728**086387**

Rasp set

- Versatile set with 3 file shapes: flat, half-round, round
- Teeth (cut): 2 = medium
- Ergonomic handle shape for a secure grip and comfortable working
- Ideal for workshops, trade and industry
- Suitable for applications on the car body



3

V7548

EAN 4047728**075480**

Battery tester

- Checking the status of battery and charging systems (12 and 24 V)
- Suitable for start-stop batteries
- For passenger cars, motorcycles, vans and boats
- Functions:
 - Status report of the battery and charging systems
 - Load indication when starting up the motor
 - Identification of defective batteries
 - Option to print the test results
- Mobile use, without power supply
- Makes it possible to check when fitted or removed
- User-friendly operation
- Reverse polarity protection prevents short circuit
- Thermal paper reel included in delivery
- Clamping cable length: 600 mm
- CCA: 100 – 1700 Ah
- IEC: 100 – 1000 Ah
- EN: 100 – 1700 Ah
- DIN: 100 – 1000 Ah

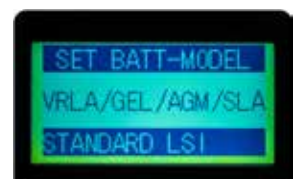

V2499N

EAN 4047728087933

Lever crimping pliers set · 6 pieces

- Parallel crimping dies prevent unevenly crimped connections, unlike standard crimping pliers
- Good leverage ratios allows reduced manual force
- Forced locking guarantees consistent crimping results
- Quick-change function for the five interchangeable crimping dies with increased crimping performance and optimised contact surface:
 - **Crimping die A:**
for insulated cable lugs
0.5 – 6.0 mm² (red, blue, yellow)
 - **Crimping die B:**
for closed, non-insulated cable lugs
1.5 · 2.5 · 6.0 · 10 mm²
 - **Crimping die C:**
for open, non-insulated cable lugs
0.5 – 6.0 mm² (width up to 6.3 mm)
 - **Crimping die D:**
for wire end sleeves with or without collar
0.5 – 4.0 mm²
 - **Crimping die F:**
for wire end sleeves 6.0 mm²

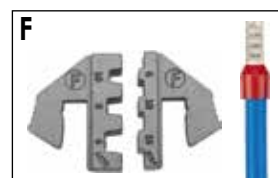

V4451

EAN 4047728044516

Cable release tool set

- Damage-free release of electrical plugs and connectors e.g. with ABS, air conditioning sensors, radio, PDC, trailer coupling modules, etc.
- Quick troubleshooting for corrosion or connection defects
- For round and flat connectors



V4326N

EAN 4047728079860

Measuring cable set

- Motor vehicle applications and 12 V batteries
- Measuring line adapters for simplifying fault diagnostics directly on the vehicle
- Polarity testers for testing hall sensor and photo sensors
- Measuring potentiometer for testing the temperature sensor and tank sensor
- Use with multimeter V4324
- 3 flat terminals, flat terminal sleeves, round terminals, pin-type cable connectors and pin-type cable sleeves



V4324

EAN 4047728043243

Digital multimeter

- Compact and practical
- High-contrast, one-line LCD display including backlighting
- 19-position rotary switch
- Reliable warning thanks to automatic overflow and polarity display for preventing possible errors
- Measuring cable with protection against contact
- DC: 200 mV – 600 V
- AC: 200 V – 600 V
- DC: 200 mA – 10 A
- Resistance: 200 – 2000 Ohm

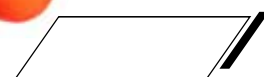

V4368

EAN 4047728087711

Pressure filling pump · manual

- For easy, effortless filling of vehicle transmissions (e.g. manual, automatic, DCT)
- Pressure build-up via spring force
- Large fill opening
- Suspension hook for safe filling and storage of the pump
- Flow regulation by means of a shut-off valve
- Roll-away protection
- Connection piece diameter 10 mm (inside 6 mm)



V4201

EAN 4047728042017

Vacuum pump

- Manual vacuum pump for extracting and filling vehicle fluids
- Pre-filling the fuel filter in vehicles without a pre-filter pump, e.g. the 2.0 l TDI **FORD** Galaxy and Mondeo
- Capacity: 1.5 l
- For the following fluids: Diesel, petrol, brake fluid, antifreeze, engine oil, gear oil, power steering oil
- Adapters included:
 - Inside 3/8" (10 mm) to outside 3/8" (10 mm)
 - Inside 5/16" (8 mm) to outside 3/8" (10 mm)
 - Outside 3/8" (10 mm) to outside 3/8" (10 mm)
 - Outside 5/16" (8 mm) to outside 3/8" (10 mm)
 - Outside variable to outside 3/8" (10 mm)



6

V4369

EAN 4047728043694

Vacuum pump

- Suction intake and decanting of fuels, oils and other liquids
- Capacity: 350 ml
- For the following fluids, among others: Diesel, petrol, brake fluid, antifreeze, engine oil, gear oil, power steering oil
- Contents:
 - 1 x hand pump 350 ml
 - 1 x PVC hose Ø 9.8 x 300 mm
 - 1 x silicon hose Ø 11 x 300 mm
 - 1 x drip plug
 - 1 x universal adapter



5

V6027N

EAN 4047728084505

Oil filler tank set

- For all common vehicle models
- Quick and uncomplicated filling of oil
- Prevents oil from spilling
- Reduces oil stains and dirt contamination in the engine compartment



16

V4385N

EAN 4047728072601

Oil filling device with adapter set

- Filling gearboxes and differentials with oil
- Incl. oil pan and 16 adapters for vehicles with very limited installation space



18

V7385

EAN 4047728077194

Gearbox tool set · MERCEDES-BENZ · 9-speed Tronic

- Draining and filling the gearbox oil on 9-speed Tronic automatic gearbox with identification 725 (725589029000 · 725589009000)
- All necessary tools for oil change
- Drain wrench for adjusting the standpipe
- Contents:
 - Oil filter adapter (for use with oil filling device V4385N)
 - Multifunction oil drain wrench
 - Oil drain plug wrench



4

V7289

EAN 4047728086653

Gear oil adapter for VAG 7-speed · 8-speed DSG

- Filling the 7-speed DQ 200 and 8-speed ZF 8DT using the gearbox vent
- Similar to OEM tool ASE40910100000



OIL FILTER TENSIONER ADJUSTERS

- **Universal**
- Mechanical locking of the oil filter wrench simplifies subsequent attachment of the reversible ratchet to the oil filter wrench
- The oil filter tensioner adjuster always remains under tension when the reversible ratchet is moved backwards
- Continuously adjustable



VIGOR No.	Height mm	■	■	EAN 4047728+
V4413	60	● 21 mm · 1/2	60-80	044134
V4414	70	● 22 mm · 1/2	80-115	044141
V4415	105	● 24 mm · 1/2	115-140	062114

V1963/28

EAN 4047728081467

Cooling system diagnosis set

New adapter series with approx. 20% space saving per adapter!

- Comfortable and efficient work, by reaching almost all expansion tanks
- Greatest market coverage
- Passenger car diagnostics
- Complete set for service work on the cooling system and heating circuit
- Comprehensive range of adapters for vehicles with water-cooled engines
- 3 features: pressure test (check for leaks in radiator system) · filling · cleaning
- Control of pressure loss via manometer
- Filling creates a vacuum in the radiator system (Advantage: coolant is sucked in without air bubbles)
- Enables filling of even large engines without thermal influences
- Universal usage due to conical rubber radiator adapter
- Measuring range: 0 – 2.5 bar



New adapter series with approx. 20% space saving per adapter!

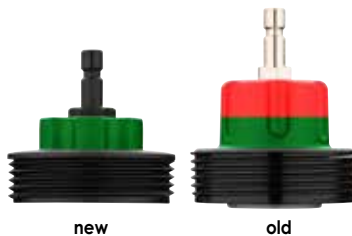

new

old

➤ **Largest model coverage on the market! Compatible with hybrid vehicles!**

28

V1963N-P

EAN 4047728088060

Cooling system diagnostics adapter PORSCHE

- M78,3 x 3,0
- PORSCHE 718 Boxster, 2020-2025
- PORSCHE Boxster 981, 2013-2025
- PORSCHE Cayman 981, 2013-2025



V1963N-SX

EAN 4047728088053

Cooling system diagnostics adapter TESLA

- M52 x 2,5
- TESLA Model S, 2012-2025
- TESLA Model X, 2015-2025



V1963N-3Y

EAN 4047728088046

Cooling system diagnostics adapter TESLA

- M42 x 3
- TESLA Cybertruck, 2023-2025
- TESLA Model 3, 2017-2025
- TESLA Model Y, 2020-2025



V4941N

EAN 4047728077293

Injector sealing seat cleaning set

- Eliminating soot residues, particles on HDi, diesel direct injection and common rail engines with Bosch and Delphi injectors
- Including sealing plug for protection against combustion chamber contamination
- Centring crowns for accurate guiding



23

V7524

EAN 4047728081320

Flue gas leakage tester

For leakage detection in closed systems

- Leaks are quickly visualised through the application of flue gas
- Operation via the 12 V on-board power supply
- Pressurisation by means of "Luft" ("air") mode and integrated manometer possible without further aids
- Smoke generation with suitable aid (we recommend our diagnostic liquid V7524-10)
- Universal application possibilities thanks to various adapters
- Built-in air compressor
- Automatic safety shutdown in case of imminent overheating
- Infinitely adjustable air flow

Diverse application possibilities, for example:

- Intake and boost pressure system
- Crankcase
- Exhaust gas and exhaust gas recirculation system
- Fuel system
- Adblue and additive system
- Tyres
- EVAP fuel system (US vehicles)
- Car body and glazing (wind noise, moisture penetration, etc.)

The indispensable diagnostics tool for your workshop



25



Included in delivery



V7524-10

EAN 4047728084321

Diagnostic liquid

- Ready-to-use diagnostic liquid for the generation of dense, white and odourless vapour in the VIGOR V7524 flue gas leakage tester
- The liquid is non-toxic and biodegradable
- The quantity of 250 ml is sufficient for numerous applications



The perfect solution for every diagnosis – 250 ml diagnostic liquid!

V4416

EAN 4047728044165

Tube flaring tool for Ø 4.75 mm brake lines

- Exclusively for DIN flaring
- Exact positioning of the brake line in the device using a spacing adapter
- Application on brake and hydraulic lines directly on the vehicle
- For thin-walled lines made of steel, aluminium and copper (metric / inch)
- No damage to coated lines
- For DIN "F" flares 180°

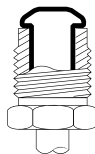

5

V4697

EAN 4047728046978

Tube flaring tool for Ø 4.75 mm brake lines

- Flared tube ends of Ø 4.75 mm lines according to DIN and SAE standards
- Extremely small construction ensures that it is possible to work in confined spaces
- No damage to coated lines
- Distance adapter prevents incorrect positioning of the brake line
- For steel, aluminium and copper lines
- For 180° DIN "F" flares, as well as SAE "F" double flares
- Contents:
 - 1 basic unit
 - 1 DIN flare adapter
 - 1 SAE flare adapter
 - 1 distance adapter
 - 1 special grease

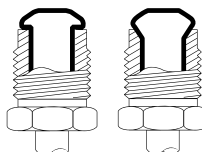

6

V1711N

EAN 4047728060738

Brake piston readjusting tool set - pneumatic

- Pushing and turning of brake pistons on nearly all passenger cars
- Efficient work on brake systems
- For clockwise and anti-clockwise brake pistons
- In addition to pneumatic support, controlled rewinding by hand is also possible



23

V7471/17

EAN 4047728077187

Brake bleeding complete set

For bleeding brake line systems and changing brake fluids

- Also for bleeding coupling systems
- Easy opening and closing of the brake nipple thanks to special hinge ratchet
- Guarantees fast access to the brake nipple even with the wheel mounted
- Angle coupling in 90° design with back pressure valve and anti-rotation protection
- Sockets: sizes 7 - 12 mm in short and long versions included in scope of delivery



Take a look!



17

V7158

EAN 4047728071581

Brake calliper screw connection set

- Brake calliper screw connection on e.g. VW · AUDI · PORSCHE · MERCEDES-BENZ · BMW · FORD · MAZDA · Volvo
- Including all common profile sizes for removal / installation of the brake calliper
- Special profiles for loosening the screw connections of separated brake callipers
- Ideal for floating and fixed brake callipers



- Nut-drivers:
 - Size 7: 24 · 65 · 92 mm length
 - Size 8: 24 mm length
 - Size 9: 20 · 50 mm length
 - Size 11: 100 mm length

12



V7259

EAN 4047728072595

Brake line bending tool Ø 4.75 mm

- Bending device for easy duplication of brake lines that keep their shape



V6917

EAN 4047728069175

Brake line ratcheting tube cutter Ø 4.75 mm

- Space saving, with ratchet mechanism
- Ratcheting mechanism in the head of the tool minimises space required – can be used directly on the vehicle
- No readjustment of the cutting wheel due to self-adjustment
- Faster cutting result than with conventional line cutters
- Adjustment of the self-adjusting cutting force possible
- Spare blades V6917-REP



V5691

EAN 4047728056915

Brake calliper file

- For removing brake dust, rust and dirt from the brake calliper without damaging the brake sleeves
- Extremely narrow design allows high flexibility
- All four sides of the square are toothed with two different thicknesses (cut)
- Width square: 9 mm



155 mm
270 mm

V5909

EAN 4047728059091

Brake hooks

- For hanging up the brake calliper during work on brakes (prevents damage to the brake hose)
- Also suitable for hanging up hoses or cables
- Surface: Dip-insulated



2



V2250

EAN 4047728022507

Brake calliper brush · steel

- Removal of stubborn brake dust
- Very slim design



200 mm

V2249

EAN 4047728022491

Brake calliper brush · brass

- Cleaning aluminium brake callipers
- Removal of stubborn brake dust
- Allows access into small brake callipers



200 mm

V6521

EAN 4047728089128

3/4" and 1" impact socket set · 24-piece

- For high torques and heavy-duty nut-driving applications
- Robust, cold-forged sockets
- Includes ratchet, extensions and adapters for flexible use
- Perfect for trucks, commercial vehicles and industrial applications
- For manual and impact operation
- Supplied in a sturdy transport case for optimum organisation and mobility



Suitable for impact wrenches

- 1 x 500 mm ratchet 3/4" drive
- 1 x 200 mm extension 3/4" drive
- 1 x adapter 3/4" x 1"
- 17 x cold-forged 3/4" impact sockets
Size: 21, 22, 23, 24, 26, 27, 28, 29, 30, 31, 32, 34, 36, 38, 41, 46, 50 mm
- 3 x cold-forged 1" impact sockets
Size: 55, 60, 65 mm
- 1 x sturdy transport case

New



24

V5034/3

EAN 4047728086318

Impact extension set*

- Material: Cr-Mo
- For impact operation
- Ideal for hard-to-reach places
- Lengths: 100, 200 and 400 mm

20 3/4" 20 3/4"



*Also available individually!

3

V7212N

EAN 4047728087858

Impact socket set

- Common screw connections for VAG vehicles, e.g. brake carriers, central drive shafts, shock absorbers or screwed wheel bearing units
- For impact operation
- Size: 14, 17, 19, 21 mm
- M14 · M16 · M18

20 3/4"



7

V6312/12

EAN 4047728083423

1/2" Impact socket set

- Damage-free operation of wheel bolts by rotating plastic sleeve
- Comprehensive set with all required sockets
- For impact operation
- Size 15 + 17 + 18.5 + 19 + 19.5 + 20.5 + 21 + 21.5 + 22 + 22.2
- KIA, HYUNDAI and MERCEDES-BENZ special profiles

125 1/2"



FORD



KIA



MERCEDES-BENZ



12

V5771

EAN 4047728088008









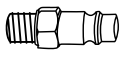

1/2" Impact wrench



12⁵ 1/2"

1/2"
1200 Nm



 Ø mm	 Nm	 max. Nm	 max. Nm	 rpm	 kg	 l/min.	 bar	 m/s ²
12,91(54)  7,2	600	850	1200	10500	1.33	141.5	6.3	10.2

V4801

EAN 4047728088015

1/2" Impact wrench











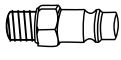

12⁵ 1/2"

*High performance
twin hammer
mechanism*

1/2"
1800 Nm



 Ø mm	 Nm	 max. Nm	 max. Nm	 rpm	 kg	 l/min.	 bar	 m/s ²
12,91(54)  7,2	850	1100	1800	7500	2.02	198	6.3	8.71

V6900

EAN 4047728088022

3/4" Impact wrench











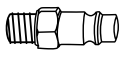

20 3/4"

*High performance
twin hammer
mechanism*

3/4"
2300 Nm



 Ø mm	 Nm	 max. Nm	 max. Nm	 rpm	 kg	 l/min.	 bar	 m/s ²
16,41(54)  7,2	1400	2000	2300	6100	3.50	290	6.3	9.803



V6028-1.5-A

EAN 4047728089067

Hydraulic aluminium service jack · 1.5 t

- Lightweight hydraulic aluminium service jack – loading capacity 1.5 t
- Smooth-running castors for optimum manoeuvrability
- Precise hydraulics for controlled lifting and lowering
- Weight: 14.5 kg

New

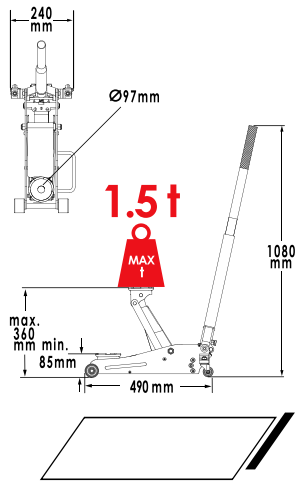

V6028-2.0-D

EAN 4047728089050

Hydraulic service jack · 2 t · ultra-flat

- Ultra-flat design – ideal for sporty and lowered vehicles
- High lifting capacity with minimal ground clearance
- Precise hydraulics for controlled lifting and lowering
- Smooth-running castors for optimum positioning
- Weight: 31.4 kg

New

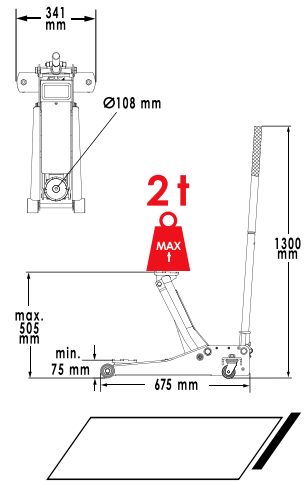

V6028-2.0-L

EAN 4047728089043

Hydraulic service jack · 2 t · extra long

- Ideal for vehicles with a longer wheelbase or difficult-to-access mounting points
- Extended lever arm for comfortable lifting
- Smooth-running castors for optimum positioning
- Weight: 45.8 kg

New

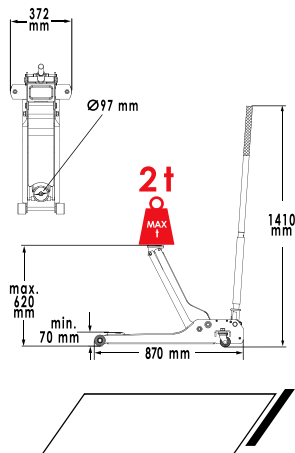

V6028-3.0

EAN 4047728089036

Hydraulic service jack · 3 t

- Powerful for SUVs, vans and heavy passenger cars
- Foot pedal enables quick attachment to the service jack socket
- Smooth-running castors for optimum positioning
- Weight: 30.7 kg

New

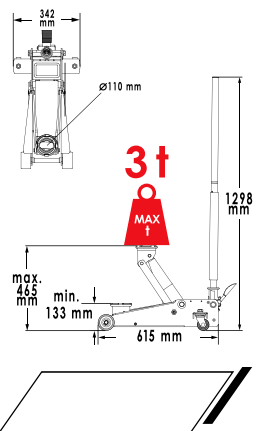

V6029-0.5

EAN 4047728**088992**

Transmission jack · 500 kg

- 500 kg loading capacity
- Ideal for safe installation and removal of gearboxes
- Infinitely adjustable working height for precise positioning via foot pedal
- Precisely adjustable hydraulics for controlled lifting and lowering
- Four swivel castors for maximum manoeuvrability under the vehicle
- Weight: 27.5 kg

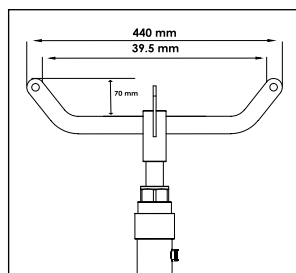
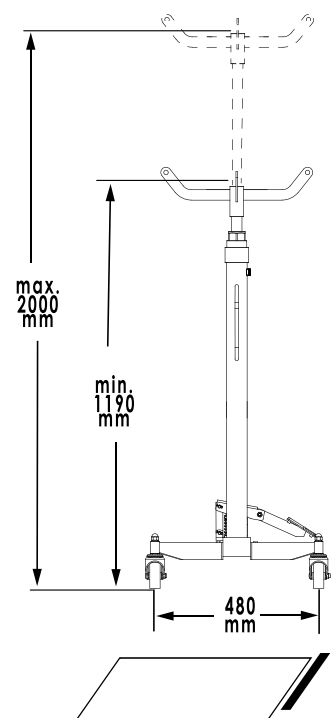

V6029/2

EAN 4047728**089906**

Hydraulic manoeuvring aid set

- Ideal for moving vehicles in confined workshop spaces or vehicles that are not roadworthy
- 680 kg loading capacity per manoeuvring aid
- 360° swivel castors for maximum manoeuvrability
- Ideal for precise positioning of cars without starting the engine

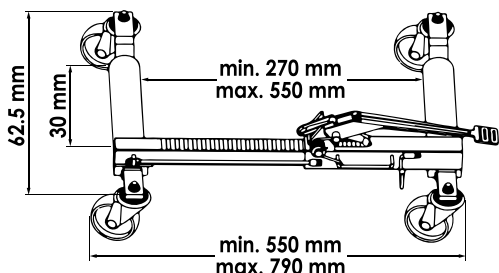
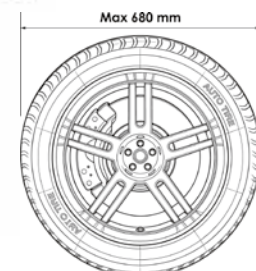

VIGOR No.	Designation	kg	EAN 4047728+
V6029-68	Hydraulic manoeuvring aid	19	088985



V6031-3.0

EAN 4047728**089012**

Jack stand set · 3 t

- Ideal for maintenance, repair and extended downtimes
- Locking mechanism for secure height adjustment with safety pin
- Wide feet for high stability on workshop floors
- Weight: 4.9 kg

New

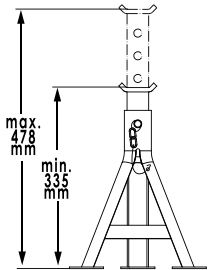

2

V6031-6.0

EAN 4047728**089005**

Jack stand set · 6 t

- Precise locking mechanism for quick and secure height adjustment
- Wide, reinforced base frame for maximum stability
- Ideal for SUVs, vans and heavy commercial vehicles
- Weight: 14 kg

New

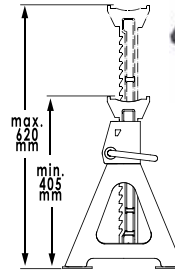

2

V6029-6.0

EAN 4047728**089029**

Bottle jack · 6 t

- Powerful hydraulic system for fast lifting
- Large, stable base plate for secure footing
- Ideal for passenger cars, SUVs, vans and light commercial vehicles
- Weight: 4.3 kg

New

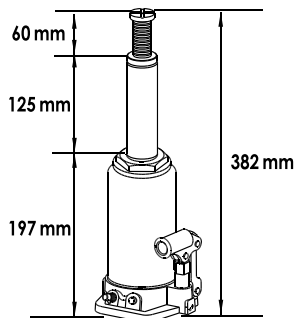

V6028-TESLA

EAN 4047728**090063**

Service jack adapter TESLA

- Precise fit for the original Tesla mounting points
- Protects the battery, sills and underbody from damage
- Non-slip, vibration-damping rubber for a secure grip

New



V6028-2.0-5

EAN 4047728**090001**

Rubber pad · thick

- Suitable for: V6028-2.0-D, V6028-2.0-L, V6028-3.0

New



NITRILE GLOVES

Protect hands from oil, grease, chemicals and dirt

- Surface structure provides good adhesion, even in oily working conditions
- Safety colour orange for better visibility in dark work spaces
- Comfortable, tear-resistant glove with good dexterity
- Touchscreen compatible
- Material: Nitrile
- Latex- and powder-free

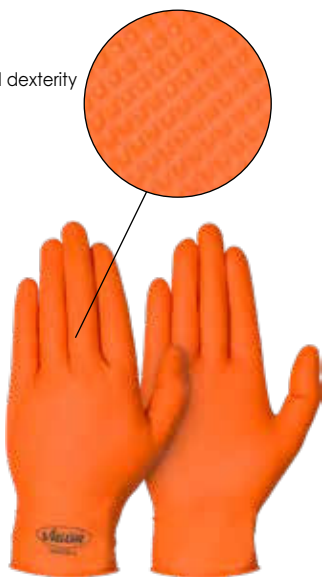

VIGOR No.		Size	EAN 4047728+
V6436-M	100 pcs./carton	M	080118
V6436-L	100 pcs./carton	L	077712
V6436-XL	90 pcs./carton	XL	077729
V6436-XXL	90 pcs./carton	XXL	077736

V6973

EAN 4047728069731

Mechanic's creeper

- Padded head rest
- Two side storage compartments for screws or other small parts
- High-quality finish made of plastic
- Easy to clean
- Six castors made of hard plastic
- Loading capacity maximum 150 kg



V4646

EAN 4047728046466

Brush set

- Professional cleaning and deburring of cylinders, tubes, bushings, etc.
- For drilling machines and pneumatic drills (when operating with power tools only use the brushes rotating clockwise)
 - 12 nylon brushes: Ø 8 · 9 · 10 · 11 · 12 · 13 · 14 · 15 · 16 · 17 · 18 · 19 mm
 - 12 steel brushes: Ø 8 · 9 · 10 · 11 · 12 · 13 · 14 · 15 · 16 · 17 · 18 · 19 mm
 - 12 brushes with brass coating: Ø 8 · 9 · 10 · 11 · 12 · 13 · 14 · 15 · 16 · 17 · 18 · 19 mm
 - 1 handle with adapter and quick lock
 - 1 extension 150 mm



12 x

12 x

12 x



1 x

1 x



38



Induction heater · 1.5 kW

- Precise, targeted heating within a few seconds thanks to state-of-the-art microprocessor technology
- No open flame, no risk to hoses, cables or plastic parts
- Convenient pistol grip with LEDs to indicate the operating status and illuminate the work area
- Quick and easy loosening of tight connections by heating via induction
- Versatile use thanks to an extensive range of standard accessories
- Fixed coils: Heating of pipes, bolts, profiles
- Flexible coils: For loosening parts that are difficult to access using special winding wire
- Flat coil for heating the car body and sheet metal, makes it easier to remove stickers, sealants etc.
- 1.5 kW output
- 3 m connecting cable, 220 V
- Hose set length: 850 mm
- Storage of the handy device in a sturdy plastic case



- Including coil ①, ②, ③, ④, for almost all application fields
- Extra-long hose set 850 mm
- Pistol grip for more comfortable use

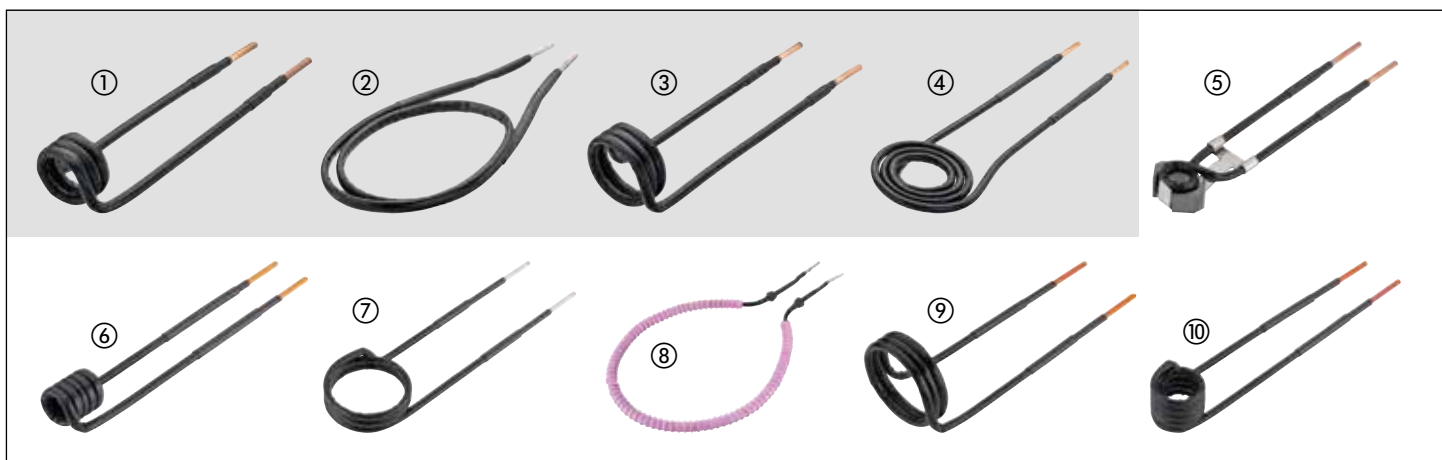

	VIGOR No.	Designation	EAN 4047728+
①	V4891N-1	Fixed coil · 19 mm · M8	088527
②	V4891N-2	Flexible coil · 750 mm	088626
③	V4891N-3	Fixed coil · 26 mm · M12	088619
④	V4891N-4	Flat coil · Ø inside 24 mm	088602
⑤	V4891N-5	Focus coil · for precise heating	088589
⑥	V4891N-6	Fixed coil · 15 mm · M6	088596
⑦	V4891N-7	Fixed coil · 45 mm · M22	088572
⑧	V4891N-8	Flexible coil · ceramic protection	088558
⑨	V4891N-9	Fixed coil · lateral 45 mm · M22	088565
⑩	V4891N-10	Fixed coil · lateral 23 mm · M10	088534



V4891-3.7

EAN 4047728**088039**

**3.7
kW**

Induction heater · 3.7 kW

- Precise, fast heating of components
- Powerful 3.7 kW variant for motor vehicle and commercial vehicle applications
- No open flame, no risk to hoses, cables or plastic parts
- Mobile use thanks to compact design with enormous power
- Extra-long, well-protected hose set of 3.0 m
- Water cooling with 1.5 litre volume
- Delivery includes coolant
- Additional fan for cooling the agent
- Output power can be precisely adjusted for the application field
- 3.7 kW output



• **Extra-long hose set including robust insulation**

• **Including 35° angled coil – Total length of the coil 500 mm**

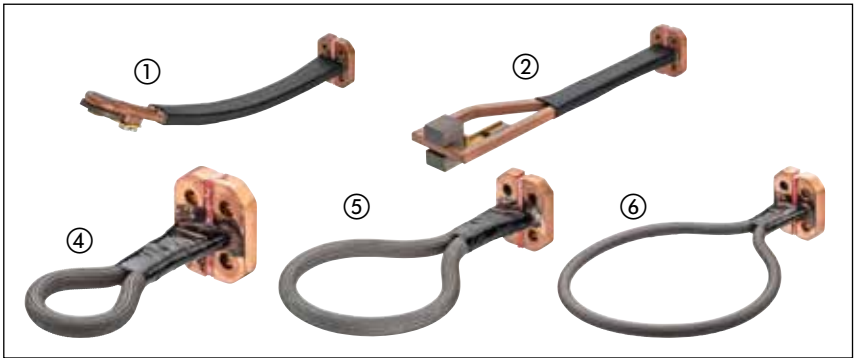

	VIGOR No.	Designation	EAN 4047728+
①	V4891-3.7-1	Focus coil · curved 500 mm	088510
②	V4891-3.7-2	Coil 90° angular · surface coil	088503
③	V4891-3.7-3	Cooling fluid 5 litres	088459
④	V4891-3.7-5	Round coil · Ø 20 mm	088497
⑤	V4891-3.7-6	Round coil · Ø 60 mm	088480
⑥	V4891-3.7-7	Round coil · Ø 100 mm	088466



V7550

EAN 4047728087704

Walnut blasting machine

- Reliably removes stubborn and baked-on residues such as soot, oil carbon and other deposits from inlet ducts, intake tracts, combustion chambers and EGR systems –without chemicals or mechanical damage
- Gentle cleaning without risk to valve seats, aluminium parts or sensitive sealing surfaces
- Thanks to the powerful extraction system, it is often possible to clean affected components without prior removal
- Walnut shell granulate as a blasting agent – a biodegradable, non-abrasive material that does not damage sensitive surfaces
- A filter function/strainer separates coarse deposits from the blasting material. Blasting material can be reused several times.
- Compressed air operation, recommended working pressure 6.3 bar
- With straight and curved lance in solid aluminium spray gun; for accessing hard-to-reach areas
- Extensive range of accessory adapters for almost all intake ducts
- Suction hose length 2.5 m
- Blasting material hose length 2 m
- 220 V power supply, cable length 3 m
- Including 5 kg of blasting agent upon delivery

Practical storage of all accessories on the back of the device!



VIGOR No.	Designation	EAN 4047728+
V7550-1	Adapter set · 24-piece	278046
V7550-2	Replacement castors	090179
V7550-3	Suction switch	090186
V7550-4	Suction unit	090193
V7550-5	Replacement hose · 2.5 m	090209
V7550-6	Connecting hoses from the container to the gun	090216
V7550-7	Blast gun · single	090223
V7550-8	Blasting nozzle set · 3-piece	090308
V7550-9	Dirt strainer	090230
V7550-11	Curved adapter mount 35 mm and 45 mm	090292
V7550-12	Dirt filter	090445





Extremely high suction power of 1600 W!

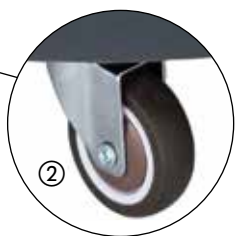

Steel castors



V7550-10

EAN 4047728088633

Walnut blasting material · 10 l

- Walnut blasting material with a grain size of 800 µm
- Suitable for walnut blasting machine V7550
- Walnut shells for chemically neutral surface treatment
- Minimises dust formation during blasting



Video borescope with probe 3.9 mm



V7501-39

EAN 4047728082037



Video borescope with probe 3.9 mm

Analysis and documentation of damage patterns in difficult to access spaces!

- Probe: \varnothing 3.9 mm
- Probe length: 1000 mm
- Camera resolution: 1280 x 720 (corresponds to HD quality)
- Camera viewing angle: 80°
- 6 dimmable LEDs
- Depth of field: 20 – 80 mm
- 5" display, swivelling
- Display resolution: 1280 x 720 pixels
- 6 Ah, 3.7 V Li-ion rechargeable battery
- 2A/5V power supply unit, USB charging cable and 32 GB TF memory card included in delivery

Screen can be moved freely in all directions



\varnothing 3.9 mm

Swivels 180° on both sides

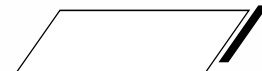
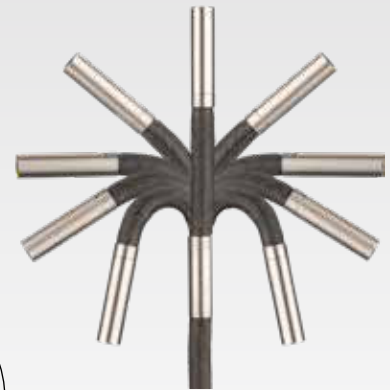

V5916

EAN 4047728059817

Ball joint ejector

- For the hydraulic removal of the ball joint pivots on steering tie rods as well as stabilisers with a maximum compressive force of 4.5 tonnes



4.5t



2



V5919

EAN 4047728090612

Expansion set for VAG wishbone clamping screw

- Expansion for V5916 for the quick and efficient removal of the clamping screw of the VAG 4-link axle



New



V7724-XL

EAN 4047728090995

Ejector for ball joints and clamping screw of the VAG 4-link axle

- Set contains ejector for ball joint V5916 and the expansions V5919, C5916-1 and V5916-2



New

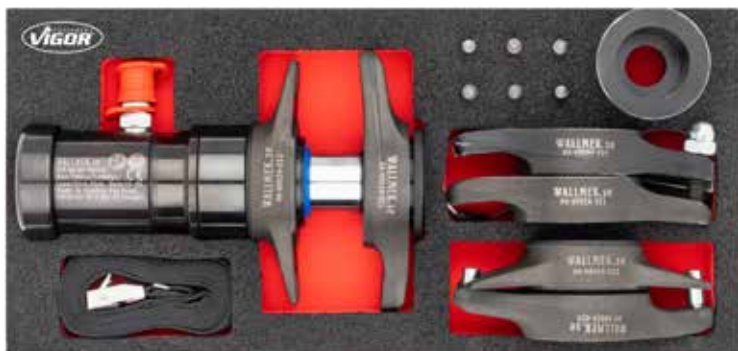

17



V5916-L

EAN 4047728090568

Ball joint ejector

- Hydraulic removal of the ball joint pivot on steering tie rods and stabilisers, or on the steering and brake levers for heavy electric vehicles, SUVs, off-road vehicles and transport vehicles
- Maximum compressive force of 8.8 tonnes
- Extra impact possible due to hammer strokes on the pressure piece
- Jaw opening 34 and 37 mm
- Height adjustment with 2 spacer rings of 16 and 26 mm in height

New



8.8t



2



V5918

EAN 4047728090636

Yoke end expansion · Jaw width 34 – 37 mm

- Ball joints on heavy electric vehicles, hybrid vehicles, and SUVs have smaller dimensions than in commercial vehicles
- The yoke end with the jaw dimensions of 34 – 37 mm also facilitates the use of the V5916-XL for these vehicles



New



V2858N

EAN 4047728075268

Press frame

- Maximum load of the supporting joints and press frame: 18 t
- Only in conjunction with V2913 · V2915 · V2914
- For e.g.: **FORD** and **MERCEDES-BENZ**

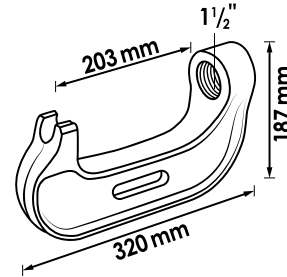
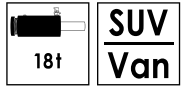

6

V5066S

EAN 4047728091015

Pressure sleeve set · short

- Pressure sleeves with an optimised height and diameter for the passenger car and transport vehicle sector can be used on both sides
- Pressure sleeve set, optimised for press frame V2858N
- Set contains diameter of 34 to 79 mm and height of 46 to 58 mm



New



13

V4905

EAN 4047728090605

Drive shaft retraction set · 14-piece

- Set for pulling in drive shafts with outside and inside threads in vehicles where the drive shaft is difficult to pull through the wheel hub
- Wide market coverage thanks to 7 adapter sleeves:
 - M 16 x 1.5 (**VAG, MAZDA**)
 - M 18 x 1.5 (**Volvo, SUZUKI, OPEL/VAUXHALL**)
 - M 20 x 1.5 (**MERCEDES-BENZ, VAG, MITSUBISHI, MAZDA**)
 - M 22 x 1.5 (**FIAT, PSA, BMW, FORD, OPEL/VAUXHALL, HYUNDAI**)
 - M 24 x 1.5 (**RENAULT, BMW, MERCEDES-BENZ, OPEL/VAUXHALL, MAZDA, HONDA, VAG**)
 - M 27 x 1.5 (**PSA, BMW, FORD**)
 - M 30 x 1.5 (**MERCEDES-BENZ, PSA, BMW**)



New



14

V5920

EAN 4047728090629

Removal / installation set · Supporting joint for Transit models from 2014

- Special set for efficient removal / installation of the pressed-in and additionally screwed-in supporting joints of **FORD** Transit models from model year 2014



New



9

V8706

EAN 4047728090537

TESLA rear axle bushing set

- Enables the simple and time-saving removal of the upper and lower ball joint bushings of the rear suspensions of **TESLA** model 3/Y
- Reducer for spindle M22 – M14
- Length of spindle: 250 mm / M14



New



9

V7030-XL

EAN 4047728091220

Drawer 1 • flat



V8366-XL • Expansion set

- Compact wheel bearing unit for Sprinter Crafter with closed wheel bearing, Sprinter now also available with up to 5-tonne approval!
- 14-piece set for pulling in drive shafts with outside and inside threads in vehicles where the drive shaft is difficult to pull through the wheel hub
- The centering sleeve set enables the guided and tilt-free installation of compact wheel bearings
- Pressure sleeve set with \varnothing of 28.6 – 43.6 mm



UNIVERSAL

Specialty tools

Drawer 2

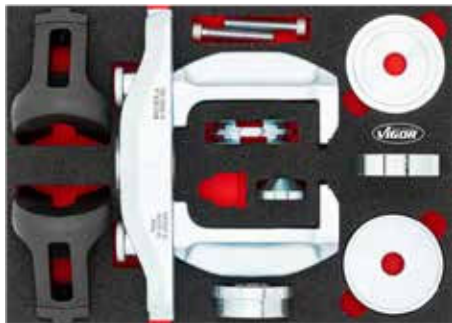

V7201 • Compact wheel bearing removal/installation tool set • universal

- For removing and installing compact wheel bearings with or without circlip
- Adjustability enables use on all types of currently available and future compact wheel bearings



V7724-XL • Ejector for ball joints and clamping screw of the VAG 4-link axle

- New expansion for V5916 for the quick and efficient removal of the clamping screw of the VAG 4-link axle
- Removal of ball joints and steering tie rod ends with bolts instead of nut threaded connections on the cone axis
- For ball joint pins with a length over 72 mm



Pneumatic foot pump

- Design with manometer
- Suitable for all series
- Working pressure: 700 bar
- Hose length: 2.2 m
- Oil tank: 1.3 l



V4906N-XL • Standard wheel bearing removal / installation set

- New adjustable bushing for diameter of 68 and 130 mm on SUVs, electric vehicles and transport vehicles
- Removal / mounting washer for bearing with \varnothing of 62 – 95 mm
- Support discs with \varnothing of 34 – 60 mm
- Circlip tool for inside circlip, clamping range 5 – 95 mm



Waste bin

- Disposal of waste or cloths
- Suitable for all series
- Also suitable for storing tools
- Capacity: 20 l



Pull-handle

- Easy manoeuvring of work benches

Drawer 3



V7261-XL • Expansion for transport vehicles and ball joints

- Short pressure sleeve set for C-press frame, height 46– 58 mm, \varnothing 34 – 79 mm
- Wheel hub puller (6 hole) 111.5 – 142.5 mm, (8 hole) 162.5 – 182.5 mm
- Drive shaft removal bolt circle (6 hole) 114 – 140 mm, (8 hole) 165 to 180 mm
- Remove screwed wheel bearings with 3/4 bolts for SUV and US pickups, up to 180 mm wheel hub

New

SALO XL
tool assortment

VIGOR XL
SERIES



Drawer 4



V4904 · Set of devices for the removal of the drive shafts

- For passenger cars with T4 and 5-hole wheel hubs due to oval holes for wheel bolts
- Avoids damage to the drive shaft and surrounding parts, as heating is no longer necessary



V5550 · Expansion set for compact wheel bearing and wheel hub

- Removal / installation of all currently known wheel bearings (together with compact wheel bearing removal and installation kit V4680)
- Additional pressure feet for the removal of screwed wheel bearing units (3 and 4 bolts) at the front and rear axle **VAG · OPEL/VAUXHALL** etc.
- Expansion e.g. for V4680
- Adjustability guarantees usage with all models of screwed wheel bearing units with 3 and 4 bolts currently available on the market



V7723 · Spindle set

- Universal expansion for 18 t and 22 t hydraulic cylinder
- Spindle set makes it possible to remove and insert bushings and bearings with various inside diameters

Drawer 5



V5066 · Pressure sleeve set

- Including 24 pressure pieces of different sizes
- Sleeves with small diameters are reversible
- Adapter and pressure shaft enable application of the press frame V2885—useful when removing or installing bushings and supporting joints without holes



V5741 · Rear axle longitudinal control arm · silent block **FORD, MAZDA, Volvo**

- For changing the bushing of the front longitudinal strut in the rear area and for changing the rear axle bushings
- Bushing and press frame can withstand loads of up to 22 tonnes



V7722N · Press frame expansion set

- Set contains:
 - 14 t compressive hydraulic cylinder including thrust rod M 24
 - Support set 275 mm
 - Open plate including screws M 16 x 40 mm



V2846

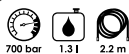

700 bar 1.31 2.2 m



V6395



V4893

V7026N-2

EAN 4047728070478

UNIVERSALO 2 Specialty tool assortment

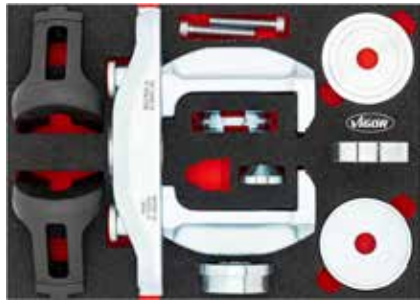

V7201N



Compact wheel bearing removal / installation set

- For removing and installing compact wheel bearings with or without circlip
- Adjustability enables use on all types of currently available and future compact wheel bearings

UNIVERSALO 2



V2846

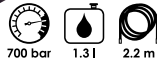

Pneumatic foot pump

- Design with manometer
- For all hydraulic cylinders
- Working pressure: 700 bar
- Hose length: 2.2 m
- Oil tank: 1.3 l



V4906N



Standard wheel bearing removal / installation set

- New effective method for removing wheel hubs; the use of the wheel bearing set V4598 is recommended here.
- The set also functions with steering knuckles with uneven and limited surfaces
- Mounting washers with \varnothing 62 – 83 mm and support discs with \varnothing 34 – 60 mm are included, the bearing shell is suitable for wheel bearings of up to a \varnothing of 92 mm



**VIGOR
SERIES XL**



V5549-1N



Compact wheel bearing expansion set

- Set contains 4 extensions:
 1. Disassembly feet for bolted compact wheel bearings (3 bolts)
 2. Disassembly feet for bolted compact wheel bearings (4 bolts)
 3. Removal unit of the wheel hub without prior removal of the drive shaft
 4. Removal unit of the screwed wheel bearing without prior removal of the drive shaft
- Especially for expanding and completing compact wheel bearing sets



V6395

Including container for storing the pump



V5009

2x



V4904



Set of devices for the removal of drive shafts

- For passenger cars with T4 and 5-hole wheel hubs due to oval holes for wheel bolts
- Avoids damage to the drive shaft and surrounding parts, as heating is no longer necessary



V7071



V4906N-XL

EAN 4047728091008

Standard wheel bearing removal / installation set

- Generation 1 wheel bearing for passenger cars and transport vehicles, universal
- Newly expanded standard wheel bearing removal / installation set
- The newly adjustable bushing included offers the possibility of accommodating larger bearing diameters between 68 and 130 mm. This makes use with heavy SUVs, electric vehicles and transport vehicles possible.
- Effective method for removing wheel hubs; the use of wheel bearing tool set V4598 is recommended here. The set also functions with steering knuckles with uneven and limited surfaces
- Allows the wheel bearings to be changed directly on the vehicle with minimum effort
- Removal / mounting washers for bearings with \varnothing of 62 – 95 mm and support discs with \varnothing of 34 – 60 mm are included
- Delivered in soft foam insert for storage in the tool trolley, optional storage in Multibox V4700-XL possible (not included in delivery)



New



36



V4906

EAN 4047728049061

Wheel hub / standard wheel bearing removal / installation set

- Effective method for removing wheel hubs
- Allows the wheel bearings to be changed directly on the vehicle with minimum time required
- Together with hydraulic cylinder or manual spindle
- No removal of ABS sensors, steering knuckles, spring struts or steering tie rods
- Installation washers with \varnothing 62 – 83 mm and support washers 34 – 60 mm are included, the bearing shell is for wheel bearings of up to 92 mm \varnothing



23



V4595

EAN 4047728090599

Adjustable bearing bushing · 68 – 130 mm

- Serves as an expansion of the standard wheel bearing removal / installation set V4906 / V4906N and offers the possibility of accommodating larger bearing diameters between 68 and 130 mm
- This makes use with heavy SUVs, electric vehicles and transport vehicles possible



New



2



V4476N

EAN 4047728068000



Hydraulic spring vice

- Can be used for almost any strut and shock absorber in passenger cars as well as lightweight vans
- By gripping the springs within the spring windings any possible awkward parts on the shock absorber are irrelevant and have no influence on the operation of the spring vice
- Tripod with included rollers enables stowing and mobile work with the spring vice

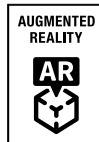
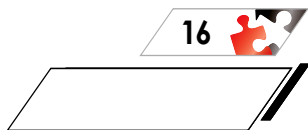

Take a look!



A safety tool
with technical sophistication!

2.1t

V4476N-H

EAN 4047728090551

Accessory · spring vice bracket

- Accessory – bracket for article V4476N
- Holds all spring plates in a secure and neat arrangement

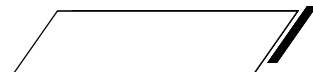

V4351

EAN 4047728090544

Spring plate for strut bearings with bolts

- Provides a tight, secure hold for strut bearings with stud bolts. Especially for spring struts with few screw turns, where it is not possible to tension them sufficiently between the turns



Including 10 spring plates

Ø 70 – 160 mm



Ø 150 – 240 mm



Ø 150 – 240 mm



① Pre-tensioning the spring



② Tensioning the spring



③ Support device



Your VIGOR specialist dealer:



VIGOR GmbH · Am Langen Siepen 13–15 · 42857 Remscheid · GERMANY
www.vigor-equipment.com · info@vigor-equipment.com

EINFACH VIGOR.