

MACHINED RING NEEDLE ROLLER BEARINGS WITHOUT INNER RING

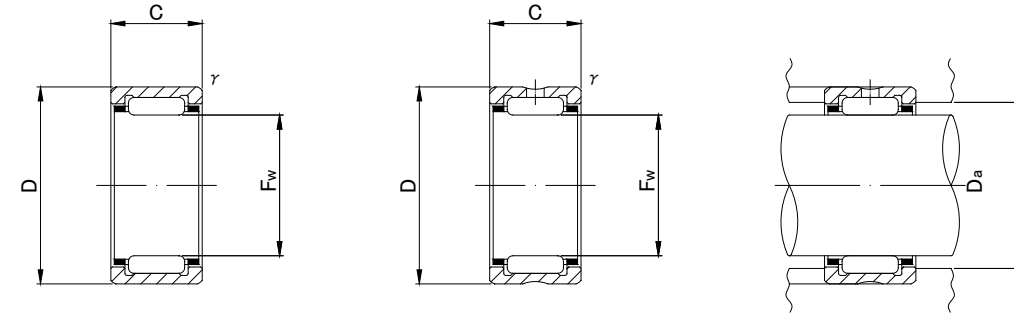
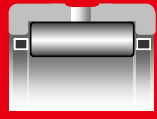

NK($F_w \leq 10$)

RNA49, RNA59, RNA69($F_w \leq 35$), NK

RNA49, RNA59, RNA69, RNA48, NK TYPE

Shaft Diameter (mm)	Designation					Dimensions (mm)				Standard mounting dimensions (mm)	Basic dynamic load rating	Basic static load rating	Limiting speed *	Mass	Usable bearing designation	
	RNA 49	RNA 59	RNA 69	RNA 48	NK	Fw	D	C	r_s min	Da MAX	Cr N	Cor N	rpm	g (approx)	INNER RING	WITH INNER RING
5	—	—	—	—	NK5/10 NK5/12	5 ^{+0.018}	10	10	0.15	6.5	2 420	1 950	40 000	3.4	—	—
	—	—	—	—		5 ^{+0.010}	10	12	0.15	6.5	3 080	2 660	40 000	4.2	—	—
6	—	—	—	—	NK6/10 NK6/12	6 ^{+0.018}	12	10	0.015	7.5	2 700	2 320	37 000	5.3	—	—
	—	—	—	—		6 ^{+0.010}	12	12	0.15	7.5	3 440	3 170	37 000	6.4	—	—
7	RNA 495	—	—	—	—	7 ^{+0.022}	13	10	0.15	8.5	2 960	2 690	34 000	5.9	IR5710	NA495
	—	—	—	—	NK7/10 NK7/12	7 ^{+0.013}	14	10	0.3	8.5	3 600	2 960	34 000	6.9	—	—
	—	—	—	—		7	14	12	0.3	8.5	4 610	4 050	34 000	8.3	—	—
8	RNA 496	—	—	—	—	8 ^{+0.022}	15	10	0.15	13.8	3 900	3 400	32 000	7.3	IR6810	NA496
	—	—	—	—	NK8/12 NK8/16	8 ^{+0.013}	15	12	0.3	13	5 100	4 700	32 000	9	IR5812	NKI 5/12
	—	—	—	—		8	15	16	0.3	13	7 100	7 300	32 000	13	IR5816	NKI 5/16
9	—	—	—	—	NK9/12 NK9/16	9 ^{+0.022}	16	12	0.3	14	5 500	5 300	30 000	10	IR6912	NKI 6/12
	—	—	—	—		9 ^{+0.013}	16	16	0.3	14	7 600	8 200	30 000	13.2	IR6916	NKI 6/16
	RNA 497	—	—	—	—	9	17	10	0.15	15.8	4 500	3 600	30 000	9.3	IR7910	NA497
10	—	—	—	—	NK10/12 NK10/16	10 ^{+0.022}	17	12	0.3	15	5 900	6 000	28 000	10.7	IR71012	NKI 7/12
	—	—	—	—		10 ^{+0.013}	17	16	0.3	15	8 200	9 200	28 000	14.3	IR71016	NKI 7/16
	RNA 498	—	—	—	—	10	19	11	0.2	17.4	6 200	5 000	28 000	12.6	IR81011	NA498
12	—	—	—	—	NK12/12 NK12/16	12 ^{+0.027}	19	12	0.3	17	6 600	7 300	26 000	12.2	IR91212	NKI 9/12
	—	—	—	—		12 ^{+0.016}	19	16	0.3	17	9 200	11 200	26 000	16.3	IR91216	NKI 9/16
	RNA 499	—	—	—	—	12	20	11	0.3	18	6 600	6 300	26 000	13.6	IR91211	NA499

* Suitable for oil lubrication. In case of grease lubrication, down to 60% of this value.

MACHINED RING NEEDLE ROLLER BEARINGS WITHOUT INNER RING

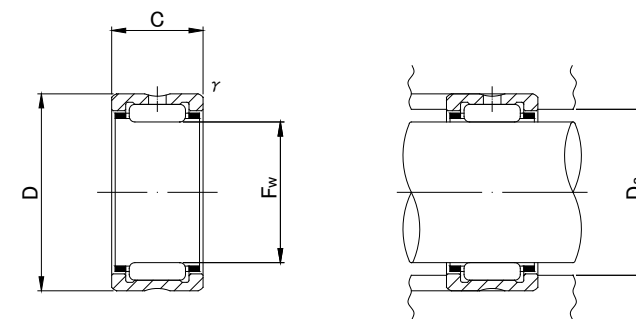
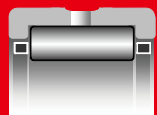

RNA49, RNA59, RNA69 (Fw ≤ 35), NK

RNA49, RNA59, RNA69, RNA48, NK TYPE

Shaft Diameter (mm)	Designation					Dimensions (mm)				Standard mounting dimensions (mm)	Basic dynamic load rating	Basic static load rating	Limiting speed *	Mass	Usable bearing designation											
	RNA 49	RNA 59	RNA 69	RNA 48	NK	Fw	D	C	f _s min	Da MAX	Cr N	Cor N	rpm	g (approx)	INNER RING	WITH INNER RING										
14	RNA 4900	—	—	—	—	14	22	13	0.3	20	9 200	10 100	24 000	16.5	IR101413	NA4900										
	—	—	—	—	14	22											16	0.3	20	11 800	13 700	24 000	21	IR101416	NKI 10/16	
	—	—	—	—	14	22											20	0.3	20	14 800	18 500	24 000	26.5	IR101420	NKI 10/20	
15	—	—	—	—	NK15/16	15	23	16	0.3	21	12 400	14 900	23 000	22.5	—	—										
	—	—	—	—	NK15/20	15											23	0.3	21	15 600	20 200	23 000	28	—	—	
16	RNA 4901	—	—	—	—	16	24	13	0.3	22	9 700	11 100	23 000	18.1	IR121613	NA4901										
	—	—	—	—	16	24											16	0.3	22	12 300	15 100	23 000	23	IR121616	NKI 12/16	
	—	—	—	—	16	24											20	0.3	22	15 600	20 400	23 000	29	IR121620	NKI 12/20	
	—	—	RNA 6901	—	—	16											24	22	0.3	22	17 100	23 000	23 000	30	IR121622	NA6901
17	—	—	—	—	NK17/16	17	25	16	0.3	23	12 800	16 300	22 000	24.5	—	—										
	—	—	—	—	NK17/20	17											25	0.3	23	16 300	22 100	22 000	30.5	—	—	
18	—	—	—	—	NK18/16	18	26	16	0.3	24	13 400	17 500	21 000	25.5	—	—										
	—	—	—	—	NK18/20	18											26	0.3	24	17 000	23 600	21 000	32	—	—	
19	—	—	—	—	NK19/16	19	27	16	0.3	25	14 000	18 700	21 000	27	IR151916	NKI 15/16										
	—	—	—	—	NK19/20	19											27	0.3	25	17 700	25 300	21 000	34	IR151920	NKI 15/20	
20	RNA 4902	—	—	—	—	20	28	13	0.3	26	10 900	13 800	20 000	21.5	IR152013	NA4902										
	—	—	—	—	20	28											16	0.3	26	13 900	18 700	20 000	27.5	—	—	
	—	RNA 5902	—	—	—	20											28	18	0.3	26	15 700	22 100	20 000	33	IR152018	NA5902
	—	—	—	—	NK20/16	20											28	20	0.3	26	17 600	25 400	20 000	35.5	—	—
	—	—	RNA 6902	—	—	20											28	23	0.3	26	19 300	28 700	20 000	37	IR152023	NA6902

* Suitable for oil lubrication. In case of grease lubrication, down to 60% of this value.

MACHINED RING NEEDLE ROLLER BEARINGS WITHOUT INNER RING

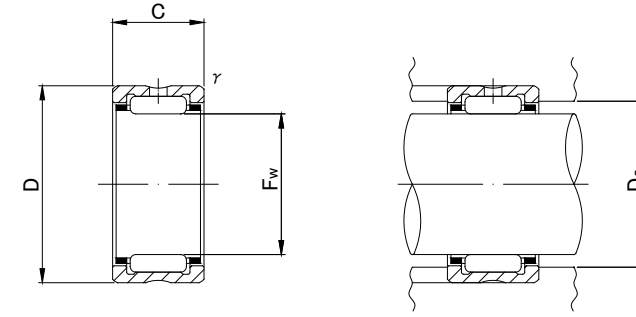
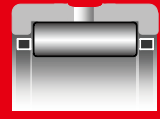

RNA49, RNA59, RNA69 (Fw ≤ 35), NK

RNA49, RNA59, RNA69, RNA48, NK TYPE

Shaft Diameter (mm)	Designation					Dimensions (mm)				Standard mounting dimensions (mm)	Basic dynamic load rating	Basic static load rating	Limiting speed *	Mass	Usable bearing designation								
	RNA 49	RNA 59	RNA 69	RNA 48	NK	Fw	D	C	f _s min	Da MAX	Cr N	Cor N	rpm	g (approx)	INNER RING	WITH INNER RING							
21	—	—	—	—	NK21/16 NK21/20	21 +0.033	29	16	0.3	27	14 400	20 000	19 000	29	IR172116	NKI 17/16							
	—	—	—	—		21 +0.020	29	20	0.3								27	18 200	27 100	19 000	36	IR172120	NKI 17/20
22	RNA 4903	—	—	—	— NK22/16 — NK22/20 —	22	30	13	0.3	28	11 800	15 600	18 000	23.5	IR172213	NA4903							
	—	—	—	—		22	30	16	0.3								28	14 900	21 200	18 000	30	—	—
	—	RNA 5903	—	—		22 +0.033	30	18	0.3								28	16 900	24 900	18 000	35	IR172218	NA5903
	—	—	—	—		22 +0.020	30	20	0.3								28	18 900	28 700	18 000	37.5	—	—
	—	—	RNA 6903	—		22	30	23	0.3								28	20 800	32 500	18 000	40.5	IR172223	NA6903
24	—	—	—	—	NK24/16 NK24/20	24 +0.033	32	16	0.3	30	15 300	22 600	17 000	32	IR202416	NKI 20/16							
	—	—	—	—		24 +0.020	32	20	0.3								30	19 400	30 500	17 000	40.5	IR202420	NKI 20/20
25	—	—	—	—	NK25/16 NK25/20 — — —	25	33	16	0.3	31	15 800	23 700	16 000	33.5	—	—							
	—	—	—	—		25	33	20	0.3								31	20 000	32 200	16 000	42	—	—
	RNA 4904	—	—	—		25 +0.033	37	17	0.3								35	21 000	25 000	16 000	55.5	IR202517	NA4904
	—	RNA 5904	—	—		25 +0.020	37	23	0.3								35	29 400	38 600	16 000	84	IR202523	NA5904
	—	—	RNA 6904	—		25	37	30	0.3								35	35 400	48 800	16 000	95.5	IR202530	NA6904
26	—	—	—	—	NK26/16 NK26/20	26 +0.033	34	16	0.3	32	16 300	24 900	15 000	34.5	IR222616	NKI 22/16							
	—	—	—	—		26 +0.020	34	20	0.3								32	20 600	33 700	15 000	43.5	IR222620	NKI 22/20
28	—	—	—	—	NK28/20 NK28/30 — — —	28	37	20	0.3	35	21 700	37 100	14 000	51.5	—	—							
	—	—	—	—		28	37	30	0.3								35	31 100	58 900	14 000	83.5	—	—
	RNA 49/22	—	—	—		28 +0.033	39	17	0.3								37	21 400	28 800	14 000	56.5	IR222817	NA49/22
	—	RNA 59/22	—	—		28 +0.020	39	23	0.3								37	29 800	44 400	14 000	92	IR222823	NA59/22
	—	—	RNA 69/22	—		28	39	30	0.3								37	36 300	56 900	14 000	97.5	IR222830	NA69/22
29	—	—	—	—	NK29/20 NK29/30	29 +0.033	38	20	0.3	36	21 600	37 200	14 000	57	IR252920	NKI 25/20							
	—	—	—	—		29 +0.020	38	30	0.3								36	30 900	59 000	14 000	85	IR252930	NKI 25/30

* Suitable for oil lubrication. In case of grease lubrication, down to 60% of this value.

MACHINED RING NEEDLE ROLLER BEARINGS WITHOUT INNER RING

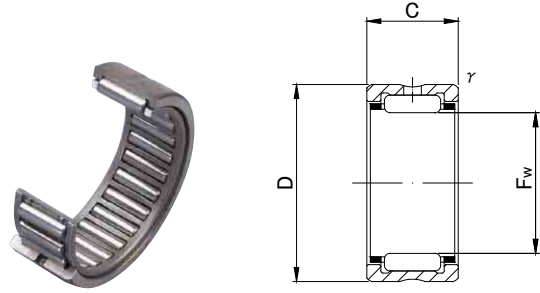
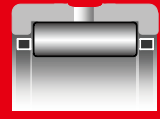

RNA49, RNA59, RNA69 (Fw ≤ 35), NK

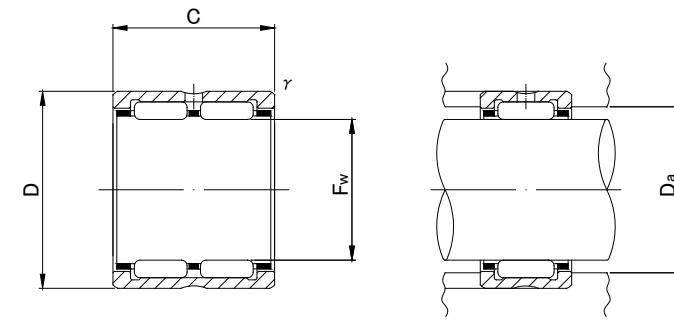

RNA69

RNA, NK

RNA, NK

RNA49, RNA59, RNA69, RNA48, NK TYPE

Shaft Diameter (mm)	Designation					Dimensions (mm)				Standard mounting dimensions (mm)	Basic dynamic load rating	Basic static load rating	Limiting speed *	Mass	Usable bearing designation	
	RNA 49	RNA 59	RNA 69	RNA 48	NK	Fw	D	C	r _s min	Da MAX	Cr N	Cor N	rpm	g (approx)	INNER RING	WITH INNER RING
30	—	—	—	—	NK30/20	30	40	20	0.3	38	25 100	40 100	13 000	64.5	—	—
	—	—	—	—	NK30/30	30	40	30	0.3	38	36 000	63 800	13 000	97.5	—	—
	RNA 4905	—	—	—	—	30 ^{+0.033}	42	17	0.3	40	23 700	30 700	13 000	64	IR253017	NA4905
	—	RNA 5905	—	—	—	30 ^{+0.020}	42	23	0.3	40	33 200	47 500	13 000	101	IR253023	NA5905
	—	—	RNA 6905	—	—	30	42	30	0.3	40	42 100	64 200	13 000	111	IR253030	NA6905
32	—	—	—	—	NK32/20	32	42	20	0.3	40	25 700	42 200	13 000	68	IR283220	NKI 28/20
	—	—	—	—	NK32/30	32	42	30	0.3	40	36 900	67 100	13 000	102	IR283230	NKI 28/30
	RNA 49/28	—	—	—	—	32 ^{+0.041}	45	17	0.3	43	24 500	32 700	13 000	76.5	IR283217	NA49/28
	—	RNA 59/28	—	—	—	32 ^{+0.025}	45	23	0.3	43	34 300	50 500	13 000	108	IR283223	NA59/28
	—	—	RNA 69/28	—	—	32	45	30	0.3	43	41 800	64 700	13 000	133	IR283230	NA69/28
35	—	—	—	—	NK35/20	35	45	20	0.3	43	27 000	46 200	11 000	73.5	IR303520	NKI 30/20
	—	—	—	—	NK35/30	35	45	30	0.3	43	38 600	73 500	11 000	112	IR303530	NKI 30/30
	RNA 4906	—	—	—	—	35 ^{+0.041}	47	17	0.3	45	25 200	34 700	11 000	72.5	IR303517	NA4906
	—	RNA 5906	—	—	—	35 ^{+0.025}	47	23	0.3	45	35 200	53 700	11 000	108	IR303523	NA5906
	—	—	RNA 6906	—	—	35	47	30	0.3	45	43 100	69 000	11 000	125	IR303530	NA6906
37	—	—	—	—	NK37/20	37 ^{+0.041}	47	20	0.3	45	28 200	50 100	11 000	77.5	IR323720	NKI 32/20
	—	—	—	—	NK37/30	37 ^{+0.025}	47	30	0.3	45	40 500	79 800	11 000	117	IR323730	NKI 32/30
38	—	—	—	—	NK38/20	38 ^{+0.041}	48	20	0.3	46	28 100	50 200	11 000	79	—	—
	—	—	—	—	NK38/30	38 ^{+0.025}	48	30	0.3	46	40 300	80 000	11 000	119	—	—
40	—	—	—	—	NK40/20	40	50	20	0.3	48	29 400	54 100	10 000	83	IR354020	NKI 35/20
	—	—	—	—	NK40/30	40	50	30	0.3	48	42 300	86 100	10 000	125	IR354030	NKI 35/30
	RNA 49/32	—	—	—	—	40 ^{+0.041}	52	20	0.6	48	31 300	47 900	10 000	96	IR324020	NA49/32
	—	RNA 59/32	—	—	—	40 ^{+0.025}	52	27	0.6	48	41 900	69 900	10 000	149	IR324027	NA59/32
	—	—	RNA 69/32	—	—	40	52	36	0.6	48	53 500	95 700	10 000	172	IR324036	NA69/32
42	—	—	—	—	NK42/20	42	52	20	0.3	50	29 900	56 200	9 500	86.5	—	—
	—	—	—	—	NK42/30	42	52	30	0.3	50	43 000	89 500	9 500	130	—	—
	RNA 4907	—	—	—	—	42 ^{+0.041}	55	20	0.6	51	32 000	50 200	9 500	113	IR354220	NA4907
	—	RNA 5907	—	—	—	42 ^{+0.025}	55	27	0.6	51	42 900	73 200	9 500	176	IR354227	NA5907
	—	—	RNA 6907	—	—	42	55	36	0.6	51	54 800	100 000	9 500	200	IR354236	NA6907

* Suitable for oil lubrication. In case of grease lubrication, down to 60% of this value.

MACHINED RING NEEDLE ROLLER BEARINGS WITHOUT INNER RING

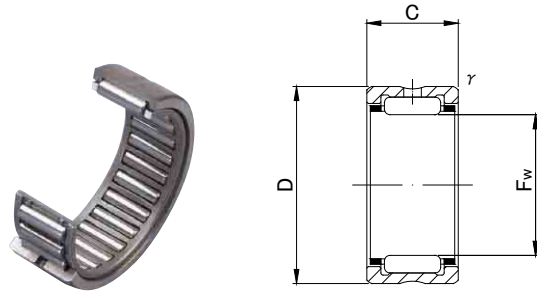
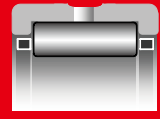

RNA49, RNA59, RNA48, NK

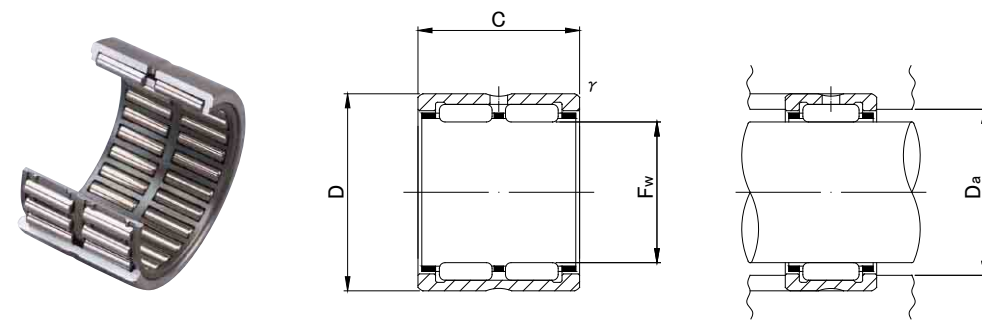

RNA69

RNA49, RNA59, RNA69, RNA48, NK TYPE

Shaft Diameter (mm)	Designation					Dimensions (mm)				Standard mounting dimensions (mm)	Basic dynamic load rating	Basic static load rating	Limiting speed *	Mass	Usable bearing designation	
	RNA 49	RNA 59	RNA 69	RNA 48	NK	Fw	D	C	rs min	Da MAX	Cr N	Cor N	rpm	g (approx)	INNER RING	WITH INNER RING
43	—	—	—	—	NK43/20 NK43/30	43 +0.041	53	20	0.3	51	30 500 43 700	58 100 92 500	9 500 9 500	88.5 133	IR384320 IR384330	NKI 38/20 NKI 38/30
	—	—	—	—		43 +0.025	53	30	0.3							
45	—	—	—	—	NK45/20 NK45/30	45 +0.041	55	20	0.3	53	31 100 44 500	60 100 95 700	9 000 9 000	92 138	IR404520 IR404530	NKI 40/20 NKI 40/30
	—	—	—	—		45 +0.025	55	30	0.3							
47	—	—	—	—	NK47/20 NK47/30	47 +0.041	57	20	0.3	55	31 500 45 200	62 300 99 000	8 500 8 500	95 144	IR424720 IR424730	NKI 42/20 NKI 42/30
	—	—	—	—		47 +0.025	57	30	0.3							
48	RNA 4908	—	—	—	—	48 +0.041	62	22	0.6	58	41 600 58 000 71 300	67 400 103 000 134 400	8 500 8 500 8 500	152 225 275	IR404822 IR404830 IR404840	NA4908 NA5908 NA6908
	—	RNA 5908	—	—		48 +0.025	62	30	0.6							
	—	—	RNA 6908	—		48	62	40	0.6							
50	—	—	—	—	NK50/25 NK50/35	50 +0.041	62	25	0.6	58	43 000 58 100	85 200 125 500	8 000 8 000	159 225	IR455025 IR455035	NKI 45/25 NKI 45/35
	—	—	—	—		50 +0.025	62	35	0.6							
52	RNA 4909	—	—	—	—	52 +0.049	68	22	0.6	64	43 500 60 700 74 600	73 400 112 000 147 100	7 500 7 500 7 500	197 232 355	IR455222 IR455230 IR455240	NA4909 NA5909 NA6909
	—	RNA 5909	—	—		52 +0.030	68	30	0.6							
	—	—	RNA 6909	—		52	68	40	0.6							
55	—	—	—	—	NK55/25 NK55/35	55 +0.049	68	25	0.6	64	45 400 61 300	94 100 138 300	7 500 7 500	193 255	IR505525 IR505535	NKI 50/25 NKI 50/35
	—	—	—	—		55 +0.030	68	35	0.6							

* Suitable for oil lubrication. In case of grease lubrication, down to 60% of this value.

MACHINED RING NEEDLE ROLLER BEARINGS WITHOUT INNER RING

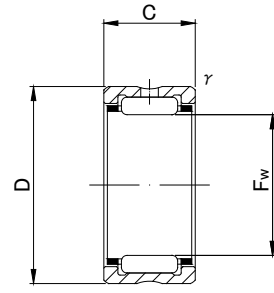
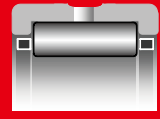

RNA49, RNA59, RNA48, NK

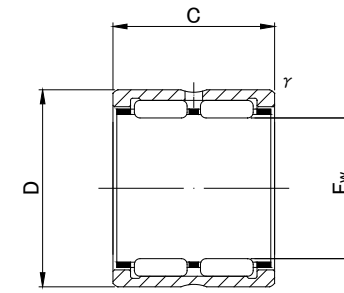

RNA69

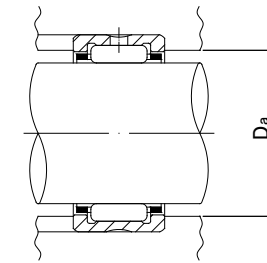

RNA49, RNA59, RNA69, RNA48, NK TYPE

Shaft Diameter (mm)	Designation					Dimensions (mm)				Standard mounting dimensions (mm)	Basic dynamic load rating	Basic static load rating	Limiting speed *	Mass	Usable bearing designation								
	RNA 49	RNA 59	RNA 69	RNA 48	NK	Fw	D	C	fs min						Da MAX	Cr N	Cor N	rpm	g (approx)	INNER RING	WITH INNER RING		
58	RNA 4910	—	—	—	—	58	72	22	0.6	68	46 200	82 100	7 000	179	IR505822	NA4910							
	—	RNA 5910	—	—	—	58 ^{+0.049}	72	30	0.6								68	64 400	126 000	7 000	289	IR505830	NA5910
	—	—	RNA 6910	—	—	58 ^{+0.030}	72	40	0.6								68	79 100	163 800	7 000	320	IR505840	NA6910
60	—	—	—	—	NK60/25 NK60/35	60 ^{+0.049}	72	25	0.6	68	47 500	103 000	6 500	187	IR556025	NKI 55/25							
	—	—	—	—		60 ^{+0.030}	72	35	0.6								68	64 100	151 000	6 500	260	IR556035	NKI 55/35
63	RNA 4911	—	—	—	—	63	80	25	1	75	57 600	97 300	6 500	265	IR556325	NA4911							
	—	RNA 5911	—	—	—	63 ^{+0.049}	80	34	1								75	82 600	154 000	6 500	367	IR556334	NA5911
	—	—	RNA 6911	—	—	63 ^{+0.030}	80	45	1								75	99 000	194 200	6 500	475	IR556345	NA6911
65	—	—	—	—	NK65/25 NK65/35	65 ^{+0.049}	78	25	0.6	74	49 600	111 800	6 000	225	—	—							
	—	—	—	—		65 ^{+0.030}	78	35	0.6								74	67 000	164 800	6 000	315	—	—
68	—	—	—	—	NK68/25 NK68/35	68	82	25	0.6	78	54 800	116 700	6 000	250	IR606825	NKI 60/25							
	—	—	—	—		68	82	35	0.6								78	72 100	165 700	6 000	350	IR606835	NKI 60/35
	RNA 4912	—	—	—	—	68 ^{+0.049}	85	25	1								80	60 100	104 900	6 000	285	IR606825	NA4912
	—	RNA 5912	—	—	—	68 ^{+0.030}	85	34	1								80	86 100	167 000	6 000	408	IR606834	NA5912
	—	—	RNA 6912	—	—	68	85	45	1								80	103 000	210 800	6 000	510	IR606845	NA6912
70	—	—	—	—	NK70/25 NK70/35	70 ^{+0.049}	85	25	0.6	81	55 500	120 600	5 500	280	—	—							
	—	—	—	—		70 ^{+0.030}	85	35	0.6								81	73 000	170 600	5 500	395	—	—
72	RNA 4913	—	—	—	—	72	90	25	1	85	62 800	113 800	5 500	325	IR657225	NA4913							
	—	RNA 5913	—	—	—	72 ^{+0.049}	90	34	1								85	89 900	180 000	5 500	462	IR657234	NA5913
	—	—	RNA 6913	—	—	72 ^{+0.030}	90	45	1								85	107 900	226 500	5 500	585	IR657245	NA6913

* Suitable for oil lubrication. In case of grease lubrication, down to 60% of this value.

MACHINED RING NEEDLE ROLLER BEARINGS WITHOUT INNER RING

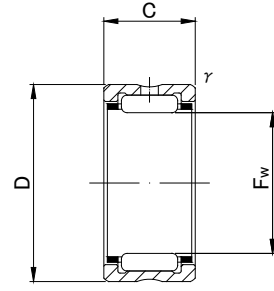
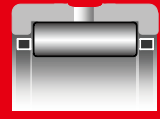

RNA49, RNA59, RNA48, NK

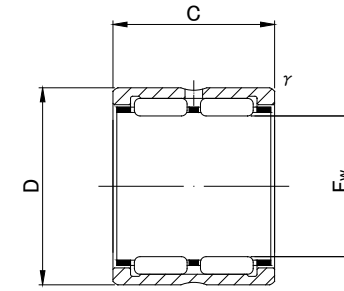

RNA69

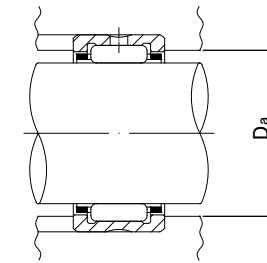

RNA49, RNA59, RNA69, RNA48, NK TYPE

Shaft Diameter (mm)	Designation					Dimensions (mm)				Standard mounting dimensions (mm)	Basic dynamic load rating	Basic static load rating	Limiting speed *	Mass	Usable bearing designation		
	RNA 49	RNA 59	RNA 69	RNA 48	NK	Fw	D	C	fs min	Da MAX	Cr N	Cor N	rpm	g (approx)	INNER RING	WITH INNER RING	
73	—	—	—	—	NK73/25 NK73/35	73 +0.049	90	25	0.6	86	61 100 80 400	126 500 180 400	5 500 5 500	335 475	— IR657335	— NKI 65/35	
	—	—	—	—		73 +0.030	90	35	0.6								
75	—	—	—	—	NK75/25 NK75/35	75 +0.049	92	25	0.6	88	62 200 82 700	130 400 186 300	5 500 5 500	345 485	— —	— —	
	—	—	—	—		75 +0.030	92	35	0.6								
80	—	—	—	—	NK80/25 NK80/35 — — —	80	95	25	1	90	59 400 78 100 83 200 112 000 133 400	137 300 194 200 157 900 232 000 310 900	5 000 5 000 5 000 5 000 5 000	315 445 495 706 910	IR708025 IR708035 IR708030 IR708040 IR708054	NKI 70/25 NKI 70/35 NA4914 NA5914 NA6914	
	—	—	—	—		80 +0.049	95	35	1								90
	RNA 4914	—	—	—		80 +0.030	100	30	1								95
	—	RNA 5914	—	—		80	100	40	1								95
	—	—	RNA 6914	—		80	100	54	1								95
85	—	—	—	—	NK85/25 — NK85/35 — —	85	105	25	1	100	76 400 86 200 102 000 116 000 138 300	145 100 169 700 209 900 249 000 330 500	4 500 4 500 4 500 4 500 4 500	435 525 610 745 960	IR758525 IR758530 IR758535 IR758540 IR758554	NKI 75/25 NA4915 NKI 75/35 NA5915 NA6915	
	—	—	—	—		85 +0.058	105	30	1								100
	—	—	—	—		85 +0.036	105	35	1								100
	—	RNA 5915	—	—		85	105	40	1								100
	—	—	RNA 6915	—		85	105	54	1								100
90	—	—	—	—	NK90/25 — NK90/35 — —	90	110	25	1	105	77 400 87 400 103 000 117 000 143 200	150 000 174 600 216 700 257 000 350 100	4 500 4 500 4 500 4 500 4 500	456 550 640 787 1 010	IR809025 IR809030 IR809035 IR809040 IR809054	NKI 80/25 NA4916 NKI 80/35 NA5916 NA6916	
	—	—	—	—		90 +0.058	110	30	1								105
	—	—	—	—		90 +0.036	110	35	1								105
	—	RNA 5916	—	—		90	110	40	1								105
	—	—	RNA 6916	—		90	110	54	1								105
95	—	—	—	—	NK95/26 NK95/36	95 +0.058	115	26	1	110	79 700 106 900	158 900 230 500	4 200 4 200	495 690	IR859526 IR859536	NKI 85/26 NKI 85/36	
	—	—	—	—		95 +0.036	115	36	1								
100	—	—	—	—	NK100/26 — NK100/36 — —	100	120	26	1	115	82 500 109 800 109 800 144 000 172 600	168 700 244 200 244 200 346 000 466 800	4 000 4 000 4 000 4 000 4 000	525 705 725 1 000 1 300	IR9010026 IR8510035 IR9010036 IR8510046 IR8510063	NKI 90/26 NA4917 NKI 90/36 NA5917 NA6917	
	—	—	—	—		100 +0.058	120	35	1.1								113.5
	—	—	—	—		100 +0.036	120	36	1								115
	—	RNA 5917	—	—		100	120	46	1.1								113.5
	—	—	RNA 6917	—		100	120	63	1.1								113.5

* Suitable for oil lubrication. In case of grease lubrication, down to 60% of this value.

MACHINED RING NEEDLE ROLLER BEARINGS WITHOUT INNER RING

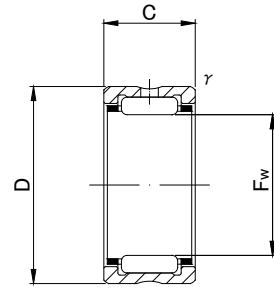
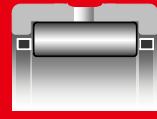

RNA49, RNA59, RNA48, NK

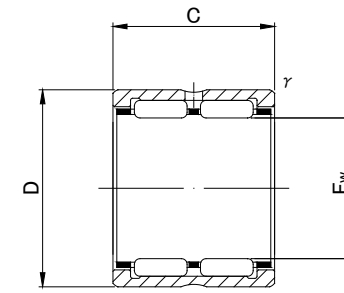

RNA69

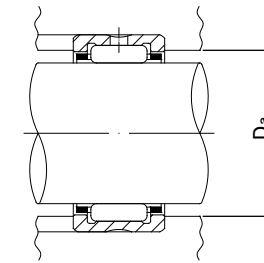

RNA49, RNA59, RNA69, RNA48, NK TYPE

Shaft Diameter (mm)	Designation					Dimensions (mm)				Standard mounting dimensions (mm)	Basic dynamic load rating	Basic static load rating	Limiting speed *	Mass	Usable bearing designation	
	RNA 49	RNA 59	RNA 69	RNA 48	NK	Fw	D	C	fs min						Da MAX	Cr N
105	—	—	—	—	NK105/26	105	125	26	1	120	84 700	177 500	3 800	545	IR9510526	NKI 95/26
	RNA 4918	—	—	—	—	105	125	35	1.1	118.5	112 800	257 900	3 800	740	IR9010535	NA4918
	—	—	—	—	NK105/36	105 ^{+0.058}	125	36	1	120	112 800	257 900	3 800	760	IR9510536	NKI 95/36
	—	RNA 5918	—	—	—	105 ^{+0.036}	125	46	1.1	118.5	148 000	365 000	3 800	1 040	IR9010546	NA5918
	—	—	RNA 6918	—	—	105	125	63	1.1	118.5	177 500	490 300	3 800	1 360	IR9010563	NA6918
110	—	—	—	—	NK110/30	110	130	30	1.1	123.5	105 900	239 300	3 600	660	IR10011030	NKI 100/30
	RNA 4919	—	—	—	—	110	130	35	1.1	123.5	116 700	270 700	3 600	770	IR9511035	NA4919
	—	—	—	—	NK110/40	110 ^{+0.058}	130	40	1.1	123.5	133 400	323 600	3 600	880	IR10011040	NKI 100/40
	—	RNA 5919	—	—	—	110 ^{+0.036}	130	46	1.1	123.5	152 000	384 000	3 600	1 130	IR9511046	NA5919
	—	—	RNA 6919	—	—	110	130	63	1.1	1 123.5	182 400	514 800	3 600	1 420	IR9511063	NA6919
115	RNA 4920	—	—	—	—	115 ^{+0.058} ^{+0.036}	140	40	1.1	133.5	145 000	329 000	3 500	1 190	IR10011540	NA4920
120	—	—	—	RNA 4822	—	120 ^{+0.058} ^{+0.036}	140	30	1	135	93 000	239 000	3 500	790	IR11012030	NA4822
125	RNA 4922	—	—	—	—	125 ^{+0.068} ^{+0.043}	150	40	1.1	143.5	152 000	357 000	3 000	1 280	IR11012540	NA4922
130	—	—	—	RNA 4824	—	130 ^{+0.068} ^{+0.043}	150	30	1	145	97 000	259 000	3 000	850	IR12013030	NA4824
135	RNA 4924	—	—	—	—	135 ^{+0.068} ^{+0.043}	165	45	1.1	158.5	187 000	435 000	3 000	1 930	IR12013545	NA4924

* Suitable for oil lubrication. In case of grease lubrication, down to 60% of this value.

MACHINED RING NEEDLE ROLLER BEARINGS WITHOUT INNER RING

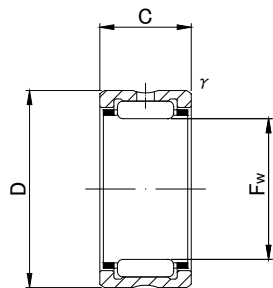
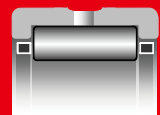

RNA49, RNA59, RNA48, NK

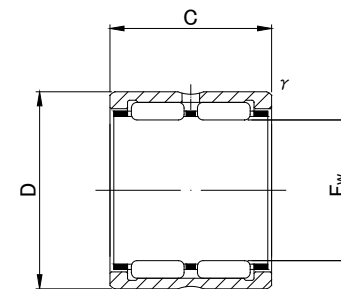

RNA69

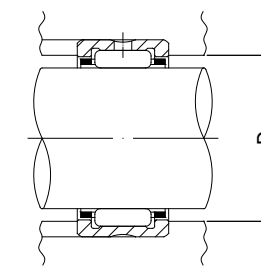

RNA, NK

RNA, NK

RNA49, RNA59, RNA69, RNA48, NK TYPE

Shaft Diameter (mm)	Designation					Dimensions (mm)				Standard mounting dimensions (mm)	Basic dynamic load rating	Basic static load rating	Limiting speed *	Mass	Usable bearing designation	
	RNA 49	RNA 59	RNA 69	RNA 48	NK	Fw	D	C	f's min	Da MAX	Cr N	Cor N	rpm	g (approx)	INNER RING	WITH INNER RING
145	—	—	—	RNA 4826	—	145 ^{+0.068} / _{+0.043}	165	35	1.1	158.5	117 000	340 000	3 000	1 100	IR13014535	NA4826
150	RNA 4926	—	—	—	—	150 ^{+0.068} / _{+0.043}	180	50	1.5	172	216 000	540 000	2 500	2 360	IR13015050	NA4926
155	—	—	—	RNA 4828	—	155 ^{+0.068} / _{+0.043}	175	35	1.1	168.5	121 000	363 000	2 500	1 170	IR14015535	NA4828
160	RNA 4928	—	—	—	—	160 ^{+0.068} / _{+0.043}	190	50	1.5	182	224 000	580 000	2 500	2 500	IR14016050	NA4928
165	—	—	—	RNA 4830	—	165 ^{+0.068} / _{+0.043}	190	40	1.1	183.5	168 000	446 000	2 500	1 750	IR15016540	NA4830
175	—	—	—	RNA 4832	—	175 ^{+0.068} / _{+0.043}	200	40	1.1	193.5	173 000	474 000	2 500	1 850	IR16017540	NA4832

* Suitable for oil lubrication. In case of grease lubrication, down to 60% of this value.